

**Geeetech Delta Rostock mini
G2 pro / G2s pro
Building Instruction**

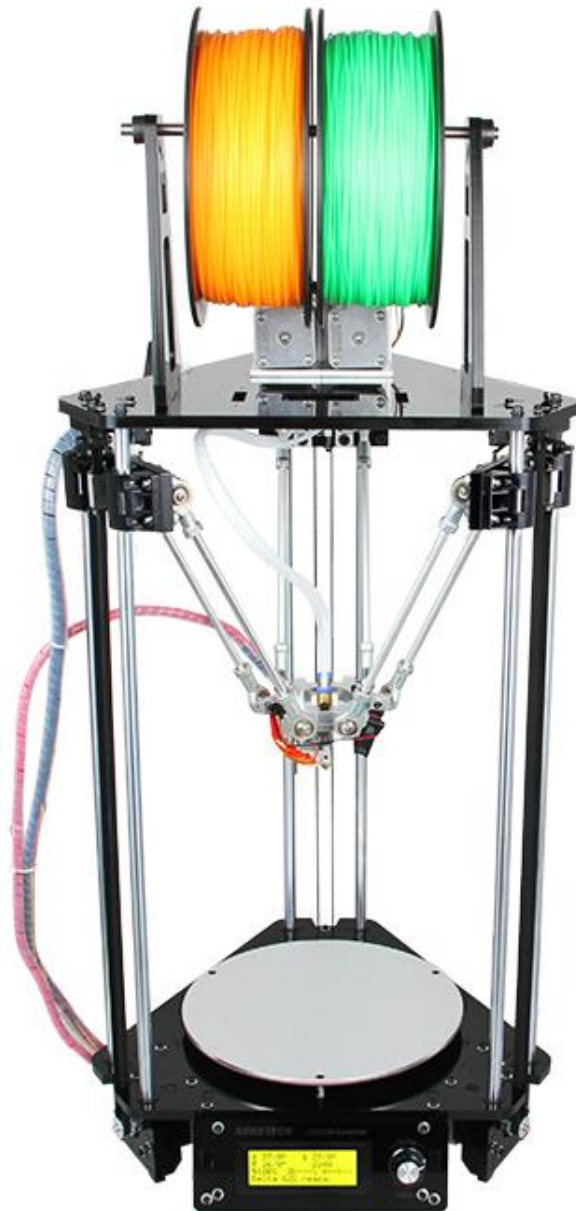

(Document version: 04-11, 2016)

CONTENT

Safety Instructions	1
Preparation	2
1 Base Assembly	3
1.1 Motor holder assembly.....	3
1.2 Connect motor ends to base plate.....	5
1.3 Mount the LCD panel	8
1.4 Mount the fan.....	13
1.5 Mount the control board.....	15
1.6 Mount the print bed.....	17
2 Top Plate Assembly.....	22
2.1 Drive wheel mount.....	22
2.2 Endstop mount	23
3 Assembling the carriage	27
4 Assemble the print platform.....	33
4.1 mount the fan	33
4.2 Mount the Probe mount.....	35
4.3 Mount the rod-end bearing holder and diagonal rod.....	36
4.4. Mount the endstop and the probe.....	39
4.5 Mount the hotend.....	41
5 Mount the smooth rods	42
6 Mount the carriage and the top plate.....	45
7 Mount the Belt	49
7.1 Assemble the drive wheel	49
7.2 Add the belt.....	53
8 Connect the Diagonal Rod to the carriage	56
9 Mount the extruder.....	58
10 Mount the filament holder.....	61
11 Connect the feeding pipe.....	64
12 Wiring	67
1Connect wires for motors.....	68
2Connect extruder motor(s).....	69
3Heating wires	71
4Connect wires for thermistor.....	74
5 Connect wires for endstop.....	75
6Connect wires for Fan.....	78
7Connect wires for LCD panel.....	79
8Connect wires for power input.....	81
9Connect the power cable to the input connector of PSU.....	81
13Tidy out the wires.....	84
14 Tips.....	87

Safety Instructions

Building your printer will require a certain amount of physical dexterity, common sense and a complete understanding of what you are doing. These detailed instructions have been provided to help you easily assemble your 3D printer.

However, we cannot be responsible for your health and safety whilst building or operating the printer, with that in mind be sure that you are confident with what you are doing prior to buying and commencing to build your 3D printer. Before you begin, read this entire manual so you are aware of all the individual steps and to ensure that you are confident that you can complete this task before you commence to build your 3D printer.

Building and operating your 3D printer involves working with electrically powered equipment, so all necessary precautions should be taken and adhered to. This printer operates on 12Volts which is supplied by a certified power supply, so you shouldn't ever with voltages exceeding 12V but bear in mind there can still be high currents involved and even at 12V extreme caution and safety awareness should be taken at all times.

3D printing involves high temperatures. The Extrusion nozzle of the hot end can run about 230 °C, the heated bed runs 110 °C and the molten plastic extruded will initially be at around 200 °C, so special care and attention should be made when handling these parts of the printer during operation.

It is not recommended that you leave your printer running unattended, or at least until you are confident to do so. We cannot be held responsible for any loss, damage, threat, hurt or other negligent result from either building or using the printer.





Preparation

1. Unpack the kit and check that all parts have been supplied with the kit. Check the condition of each part as there might be some damage during shipping. To help you with this procedure we have supplied you with a bill of materials (BOM) which can be found in the box. Each part has been packed in a bag with an easily identifiable part number.
2. Should you identify damaged, missing or incomplete parts, please contact our customer service immediately by email or through the website. At the bottom of the BOM, there is a signature of reviewer, please take a picture of it and attach the picture in your mail.
3. Read through each chapter of these instructions to gain an over-all idea of what is involved and how long it might take, before starting on the work described.
4. Before you start, you can sort all the parts in order, this will save you time especially when trying to identify individual screws and nuts. Take care not to mix up these parts as they may appear to be very similar to each other.
5. Ensure you have the necessary skills to carry out the work, or enlist the help of someone who does.
6. Work on a big firm table or bench in a clean dry well-lit area.
7. This kit contains tiny parts; please keep them away from kids under 3.
8. If you run into problems, ask for help – our contact details are on our website and we will always do our best to resolve any problems you may encounter quickly and efficiently.
9. Due to parts upgrade and production batch is different, the pictures on the manual might be a bit different with what you actually received, but the function and installation will not be change. Geeetech reserves the right to explain.

10. Step-by-step videos are available for you to refer to. Please combine this instruction manual with the online videos to help you finish the work. For access to the instruction videos, please subscribe our [YouTube Channel](#).

1 Base Assembly

1.1 Motor holder assembly

Name	Part #	Qty.	Pic
Motor holder	#A3	3	
Motor holder support	#A4	6	
Square nut	#13	6	
M3 x 16 Screw	#20	6	
M3 washer	#5	6	

Step1: Select 1 A3 and 2 A4 parts and screw them together with the M3 x 16 (#20) screws, M3 square nut (#13) and M3 washers (#5) provided.

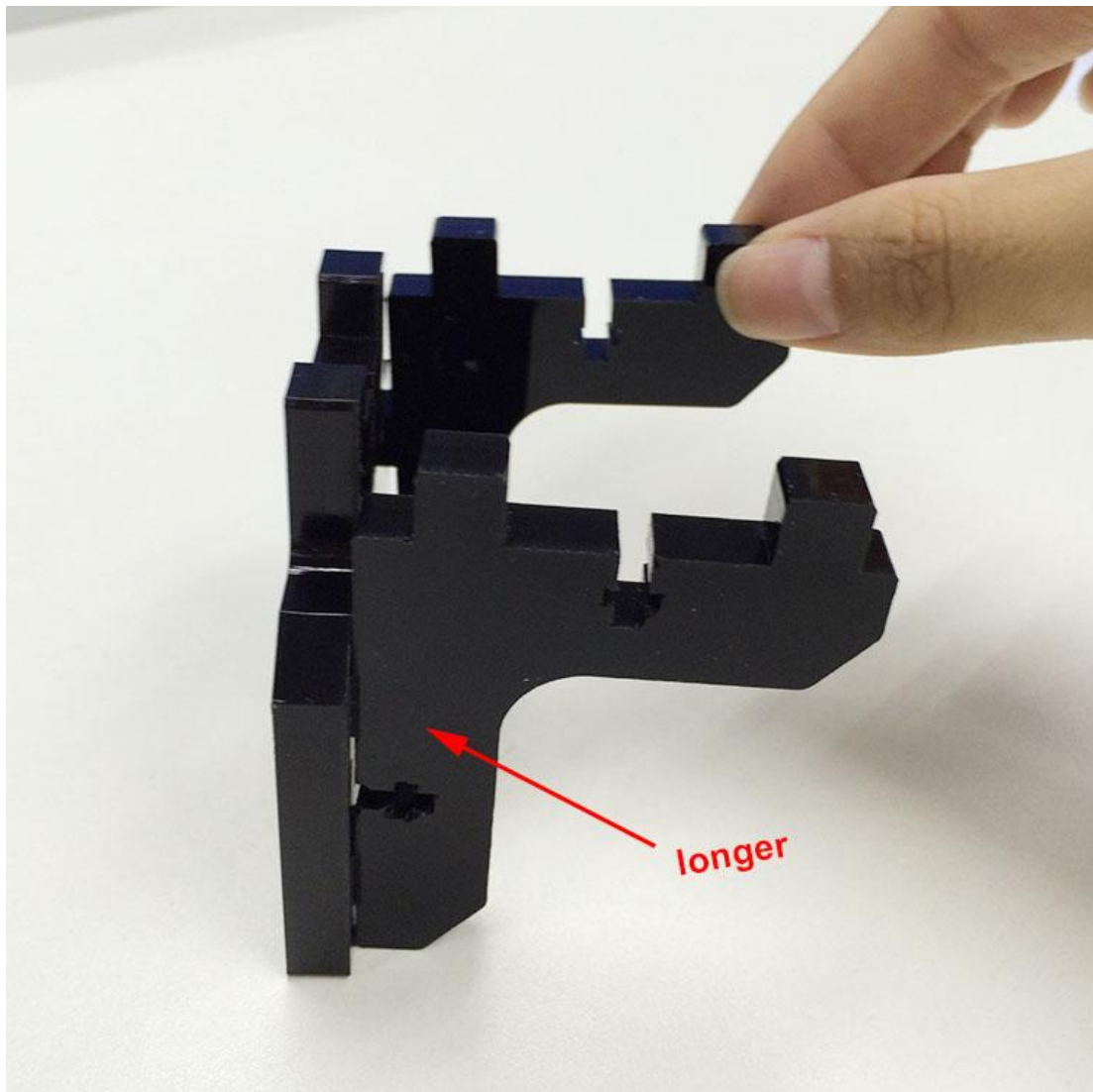

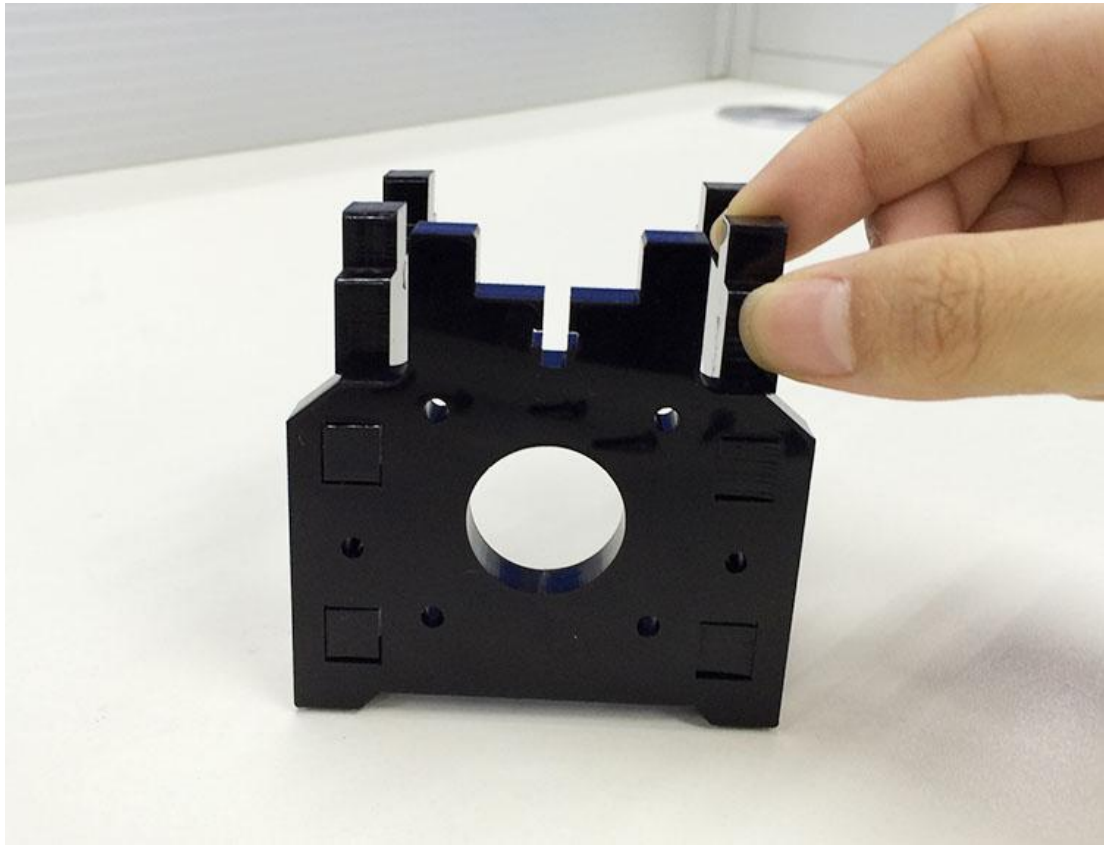

Take note, when assembled one side of the assembly is longer than the other side.



Repeat the above steps for the other 2 motor holder assemblies.

[Videos](#)

1.2 Connect motor ends to base plate

Name	Part #	Qty.	Pic.
Base plate	#A2	1	
Square nut	#13	9	
M3 x 16 Screw	#20	9	

M3 washer	#5	21	
Stepper motor	#55	3	
Pulley	#34	3	
M3 x 12 Screw	#19	12	

Step1: Mount the motor holder assemblies to the 3 tower locations of the base plate (#A2). Fix them with 9 M3 x 16 Screws (#20), Square nuts (#13) and M3 washers (#5).

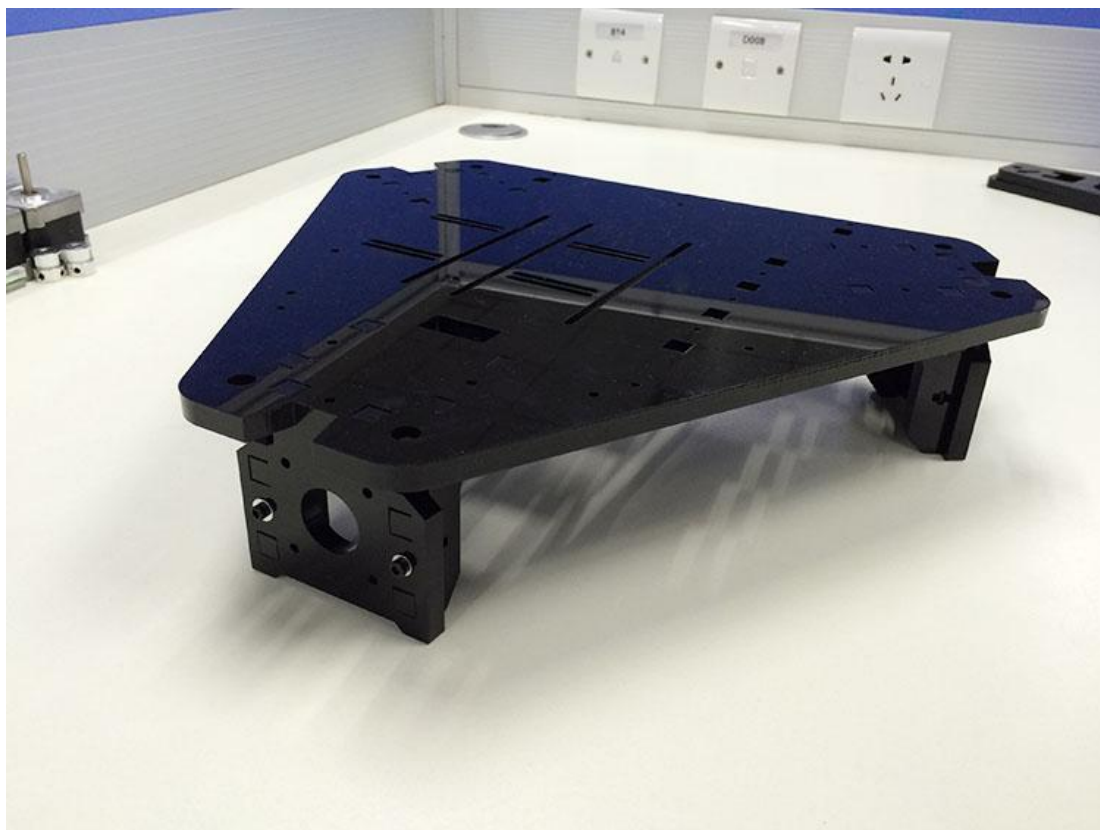

Step 2. Mount the pulley on to the motor shaft. One of the screws should be screwed on the flat section of the shaft – ensure to screw them tightly, be careful not to damage the screws.



Note:Pulley looks different here in the picture, but it will not affect the assembly and use.



Step 3. Mount the 3 motors to the assembled motor holders. Fix them with the M3x12 screws (#19) and M3 washers (#5).

* Note: It is better to have the wire connector mounted so then it is facing either left or right. Do not mount it so the connector is facing up or down as it will interfere with the base or the table.



[Videos](#)

1.3 Mount the LCD panel

Name	Part #	Qty.	Picture
LCD frame	#A8	1	
LCD support	#A9	2	
LCD2004	#49	1	

Square nut	#13	4	
M3 x 16 Screw	#20	4	
M3 x 12 Screw	#19	4	
Spacer	#37	4	
M3 washer	#5	8	
Knob	#48	1	

Step 1. Attach the LCD frame (#A8) to the support plate (#A9) with the M3 x 16 Screws (#20) and M3 square nuts (#13).



Step 2. Plug the aircraft-type spacer (#37) in to the 4 screw holes on the LCD2004 (#A8) frame.



Step 3. Assemble the LCD frame (#A8) and LCD2004 (#49) with 4 M3 x 12 Screws (#19) and washers (#5).



Step 4. Install the the knob over the protruding stalk and screw it in place with the screw located in the hole.







Step 5. Mount the assembled LCD kit onto the base plate. Screw it up with 2 M3 x 16 screws (#20), M3 square nuts (#13) and washers (#5).







[Videos](#)

1.4 Mount the fan

Name	Part #	Qty.	Picture
Fan (40x40x10)	#45	1	
M3 x 16 Screw	#20	1	
M3 x 25 screw	#22	2	

M3 Square nut	#13	1	
M3 nut	#10	2	
M3 washer	#5	3	

Step 1. Mount the fan to the fan mount, screwing it up with 2 M3 x 25 screws (#22), M3 nuts (#13) and washers (#5).

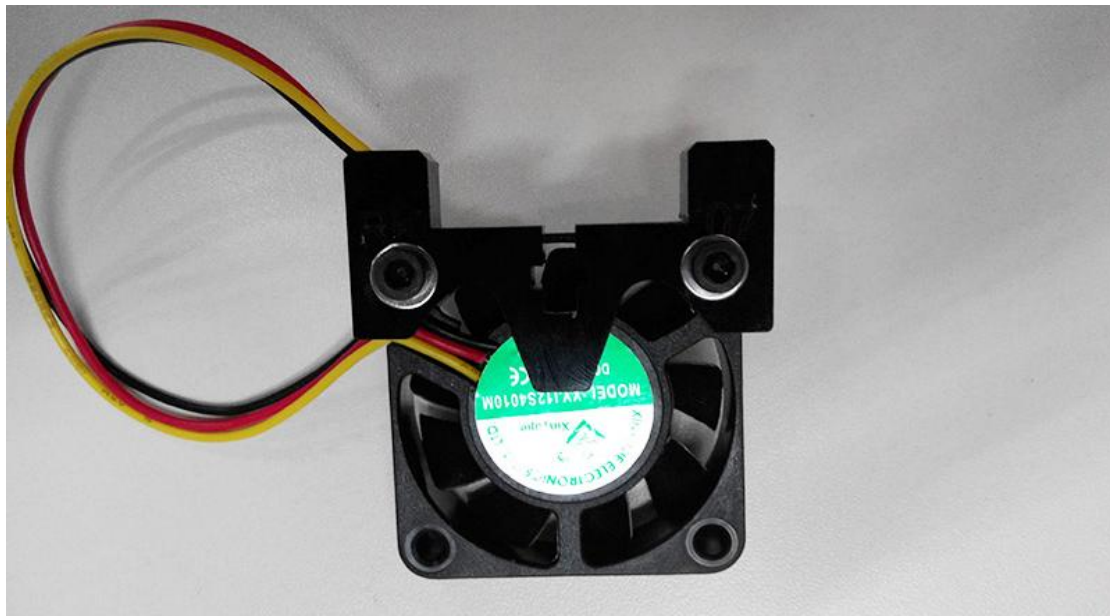





Step 2. Mount the assembled fan mount to the base plate (#A2) with a M3 x 16 screw (#20) and M3 square nut (#13) and washer (#5).



[Videos](#)

1.5 Mount the control board.

Name	Part #	Qty.	Picture
Control board GT2560 set	#50	1	
Spacer	#37	4	

M3 x 12 Screw	#19	4	
M3 washer	#5	4	

Step 1. Plug the aircraft-type spacer (#37) into the 4 screw holes on the underside of the control board (#50).

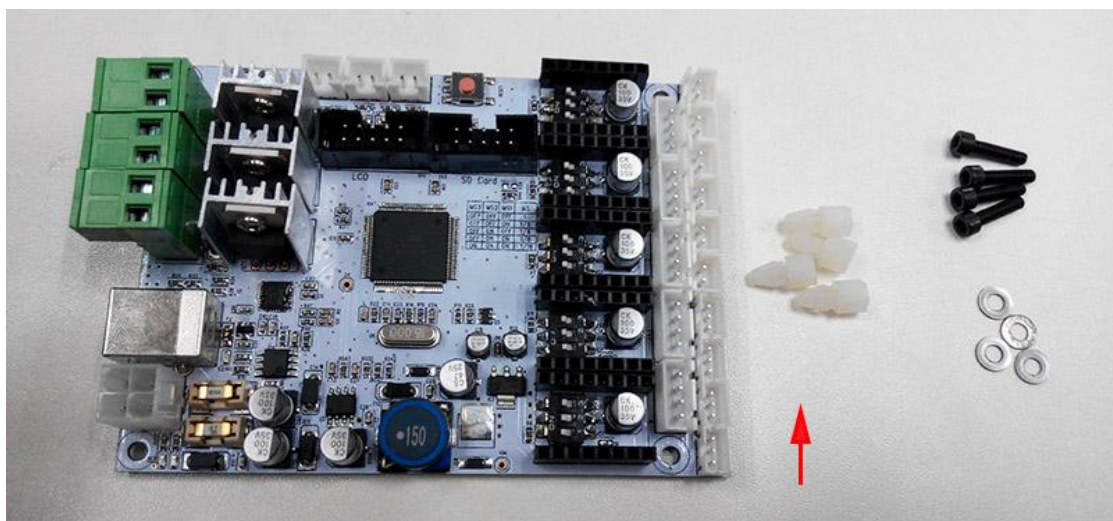

Step 2. Attach the control board (#50) to the base plate (#A2) with 4 M3 x 12 Screws (#19) and m3 washers (#5).

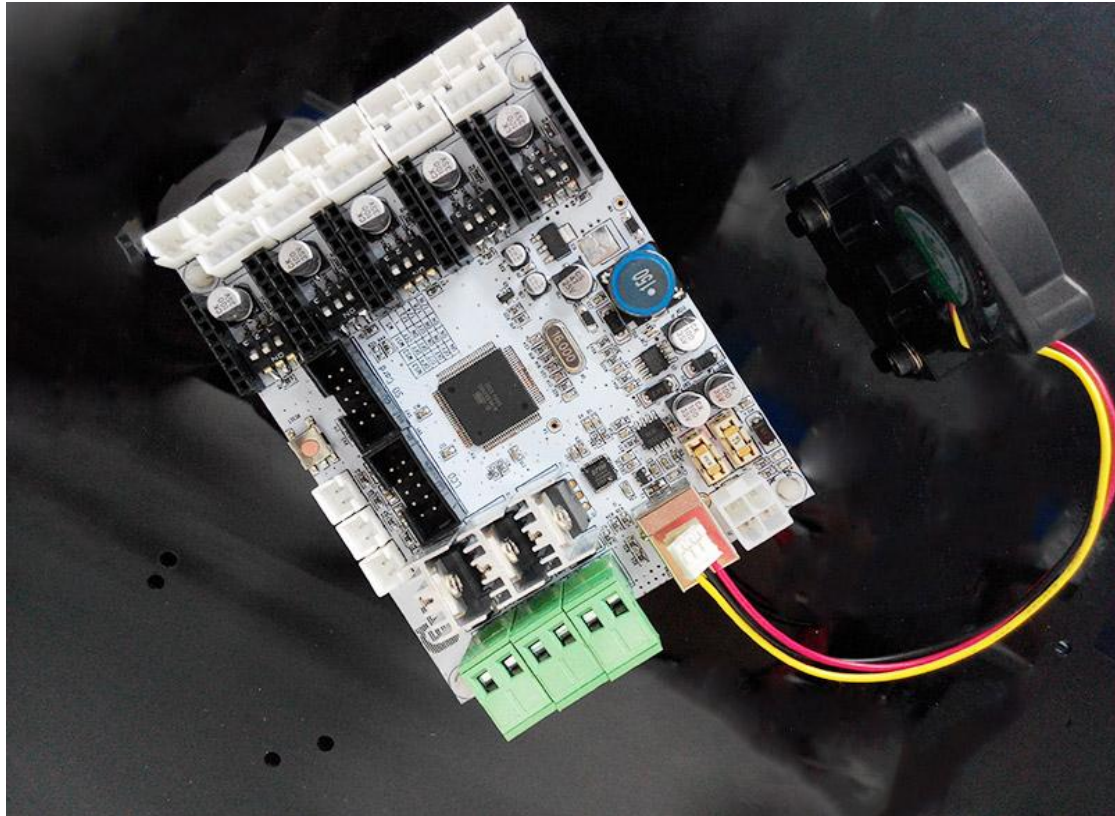







Note: It is better to have the fan pointing directly towards the MOSFET located on the control board (as pictured above).

Don't forget to stick the heat sink(#42) on the chip of the A4988 stepper motor driver with sticker(#41).

[Videos](#)

1.6 Mount the print bed.

Name	Part #	Qty.	Picture

Building platform	#M8	1	
Heat-bed	#54	1	
Hex Counter-sunk-head screw	#14	3	
Spring 3.5 x 20mm	#28	3	
Wing nut	#12	3	
M3 washer	#5	6	

* Note: For your convenience the heat-bed has been pre-soldered you can quickly and easily mount them together.

Step1. Stack the building platform (#M8) on top of the heat-bed (#54) keeping the holes aligned.



Step 2. Thread the M3x30mm Hex Counter-sunk-head screw (#14) through the building platform (M8) and heat-bed (#54), add washers (#5) and spring (#28); the assembly should now like this:



Step 3. Locate the assembly over the holes provided in the base plate (#A2) and then lock the complete assembly in place with a wing nut (#12).

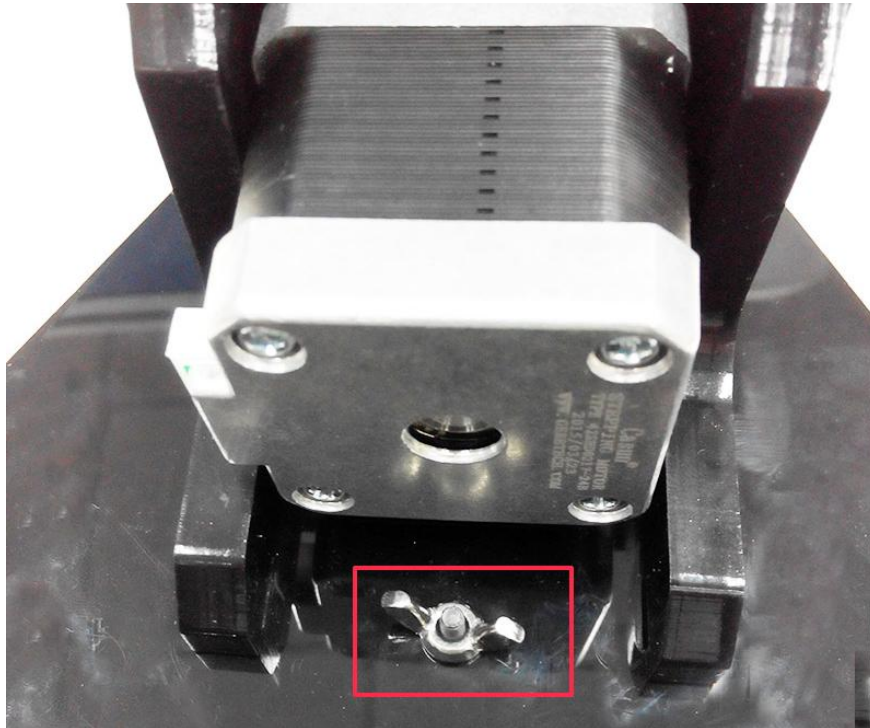



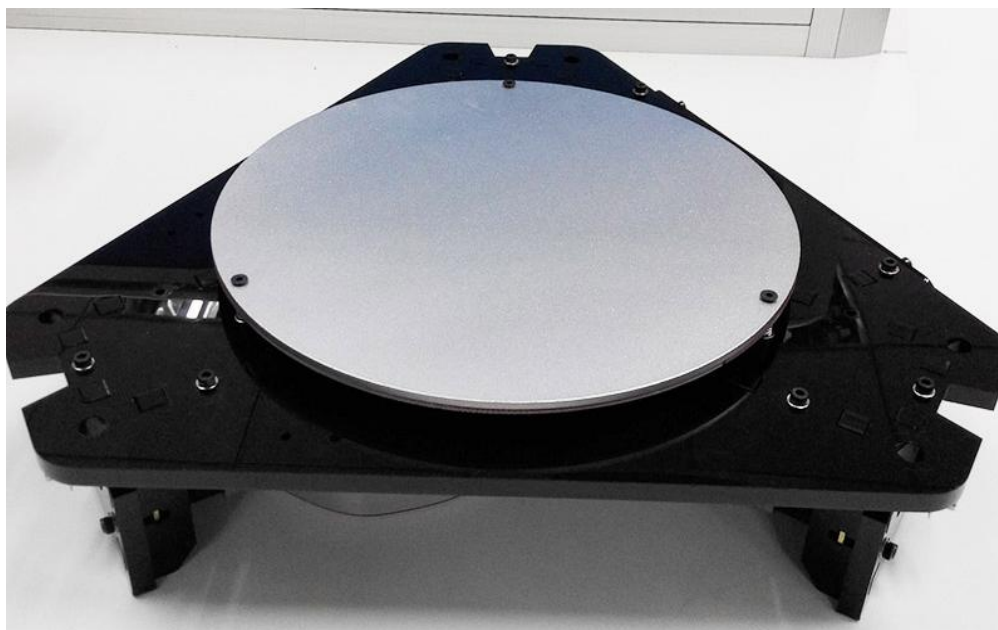

Here is the finished picture.



[Videos](#)

2 Top Plate Assembly

2.1 Drive wheel mount

Name	Part #	Qty.	Picture
Drive wheel mount	#A5	3	
M3x25 Screw	#22	6	
M3 nut	#10	6	
M3 washer	#5	6	



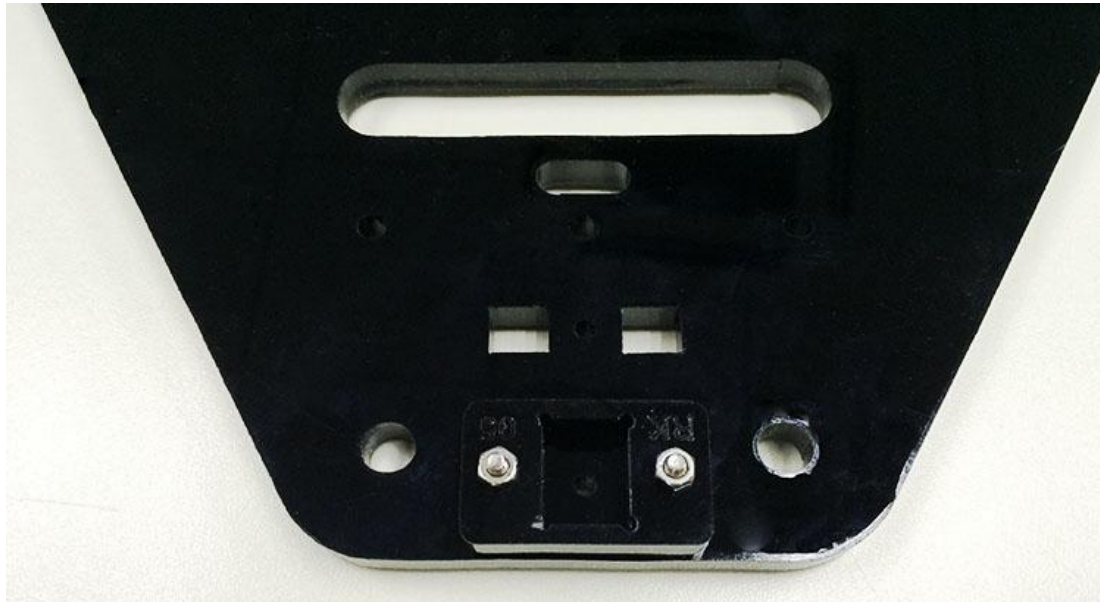

Step 1. Mount the drive wheel mount to the top plate (#A5) on A1; screw them up with M3 x 25 screws (#22) , M3 nut (#10) and washers (#5).







Repeat the procedure for the other two drive wheel mounts.

[Videos](#)

2.2 Endstop mount

Name	Part #	Qty.	Picture
Top plate	#A1	1	
Endstop mount	#A6	3	
Endstop	#44	3	
M2.5 x 16 screw	#17	6	

M3 x 16 Screw	#20	3	
Square nut	#13	3	
M3 washer	#5	9	
M2.5 nut	#9	6	

Step 1. Mount the three endstops (#44) onto the endstop mounts (#A6) in the same direction. Fix in place with with M2.5 x 16 screws (#17) and M2.5 nut (#9) ensuring that they are tightly fixed.

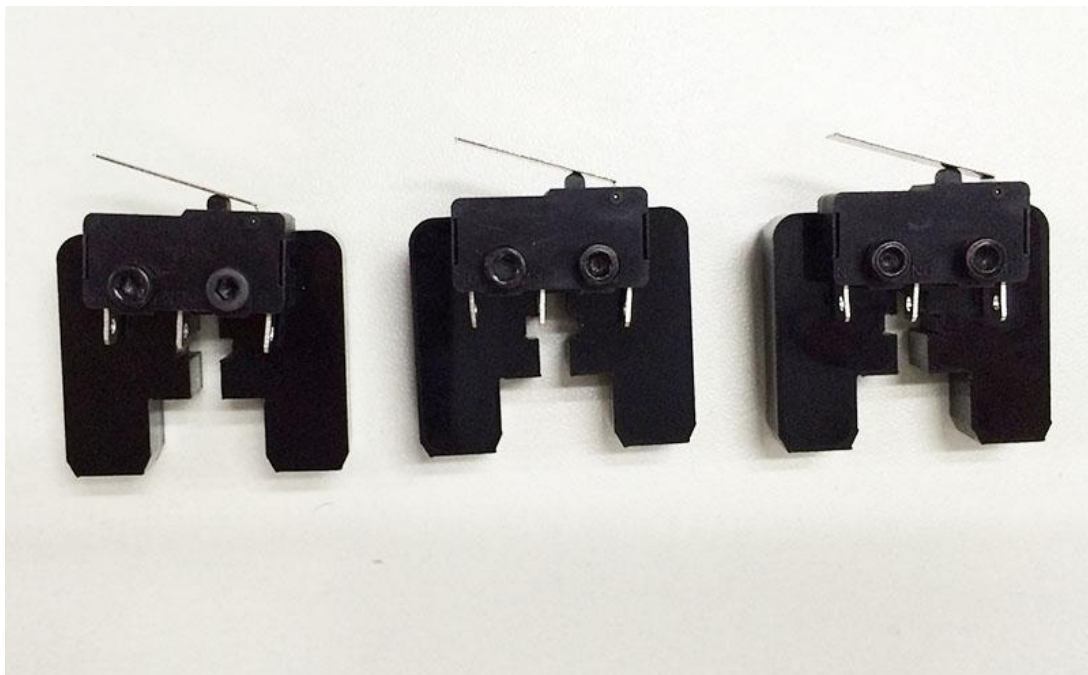

Step 2. Bend the wire connector a small amount taking care not to break the connector.

Note: You should be very gentle and note the direction, or the connector will easily break.

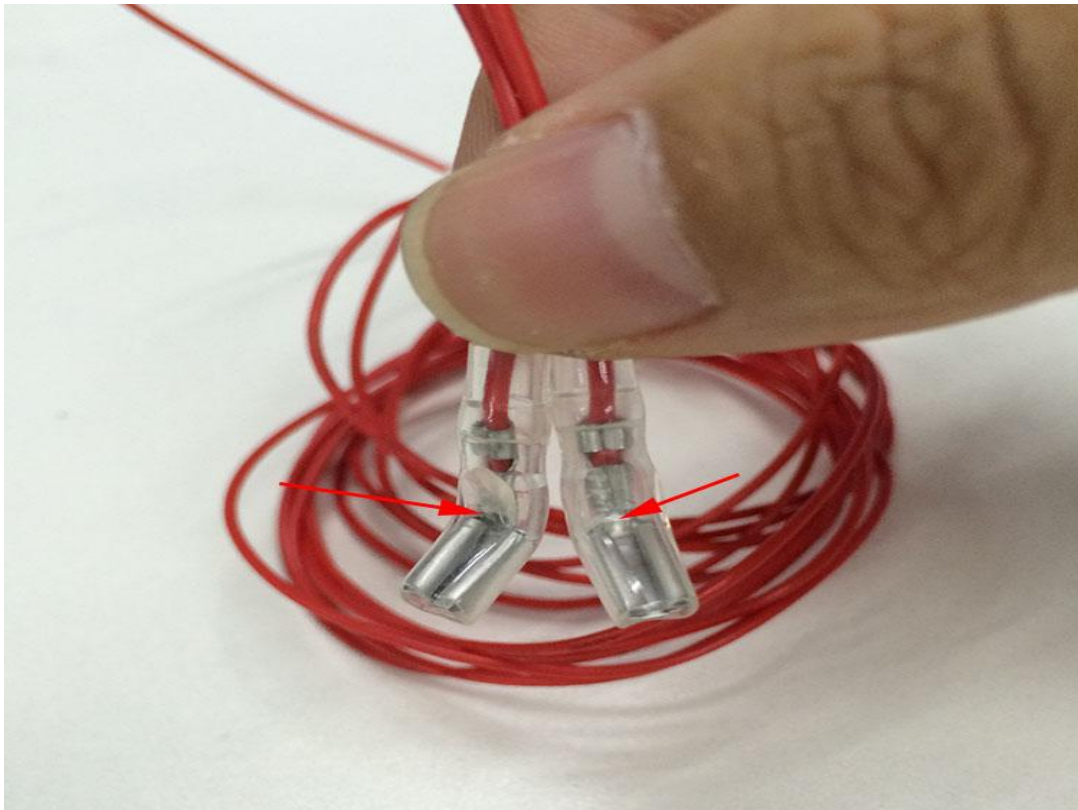

Step 2. Mount the assembled parts onto the top plate (#A1). And attach them with the M3 x 16 screws (#20), M3 square nuts (#13) and M3 washers (#5). Again, take note of the endstop mounting direction.

* Note: The opening of all the endstops should either be in the clockwise or anti-clockwise direction – but they need to be all mounted in the same direction.

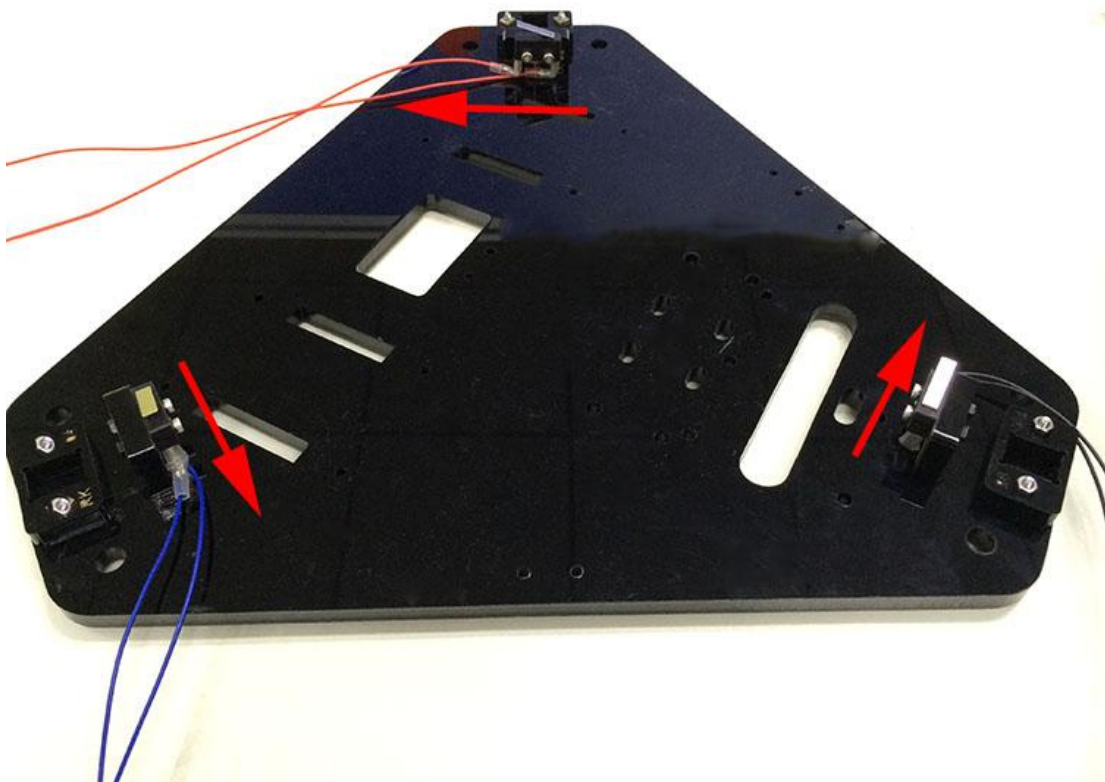

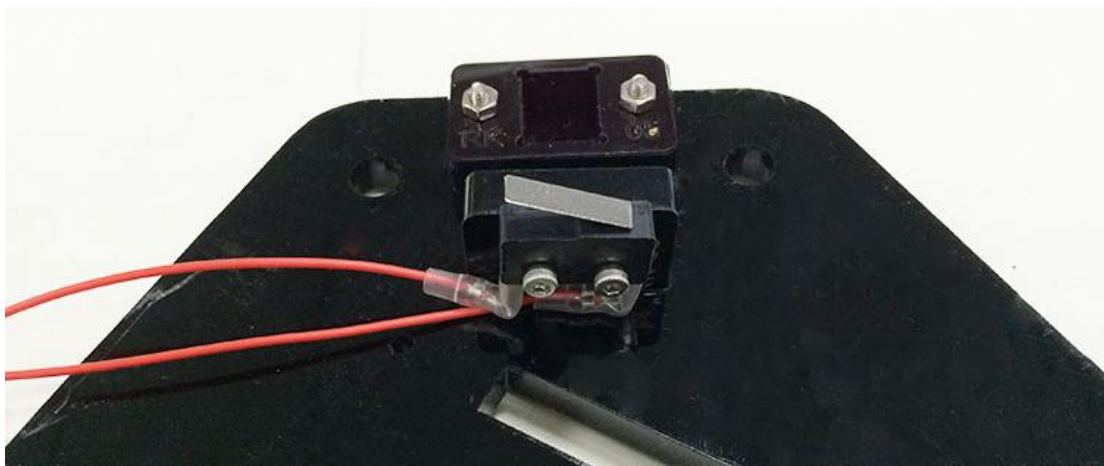
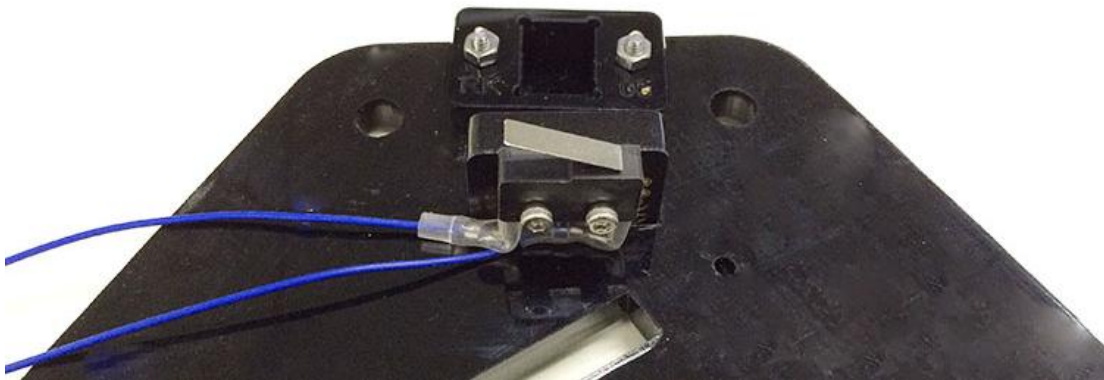
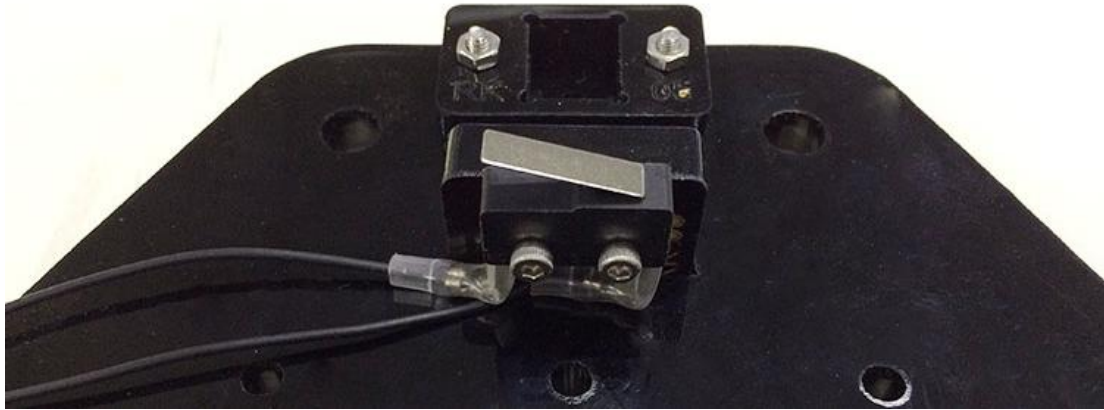



[Videos](#)

3 Assembling the carriage

Name	Part #	Qty.	Picture
Carriage mount	#A12	3	
Belt mount	#M5	3	
Endstop trigger mount	#M6	3	
Diagonal Rod joint	#M7	6	
PCS10UU Linear Bearing	#35	6	
M3x12mm Screw	#19	12	
M5x16mm Screw	#27	12	
M5x20mm Screw	#27A	12	
M3x40mm Screw	#23	3	
Spring	#29	3	
M3 washer	#5	24	

Rod-end bearing holder	#3	6	
M5 nut	#10A	24	

* PCS8UU linear bearings is a modified version of PCS8UU linear bearings, the block is made of high strength ABS, which is lighter and more flexible.

Why we changed the PCS8UU linear bearings into the PCS8UU ?

To lighten the loads of the carriage in case it slide down during printing and to reduce the drag of each axis so that the carriage can move more flexible therefore increase the precision of printing.

- Step 1. Fix the belt mount (#M5)on the carriage mount (#A12) using 2 M3 x12 screws (#19) and washer (#5).
- Step 2. On the other side of the carriage mount (#A12) fix the endstop trigger mount again with 2 M3 x 12mm screws (#19) and washer (#5).
- Step 3. Connect the diagonal rod joint (#M7) and the PCS10UU linear bearing (#35) on to the carriage mount (#A12) ensuring that the bearing sleeves (round holes to fix the rod-end bearing holder) are mounted to the outside of the assembly (refer to the picture below). Fix with M5x16mm screws (#27) and M5x20mm screws and M5 nuts.

Note: Take special note of the direction of the diagonal rod joint, the wider edge is near the Endstop trigger mount.

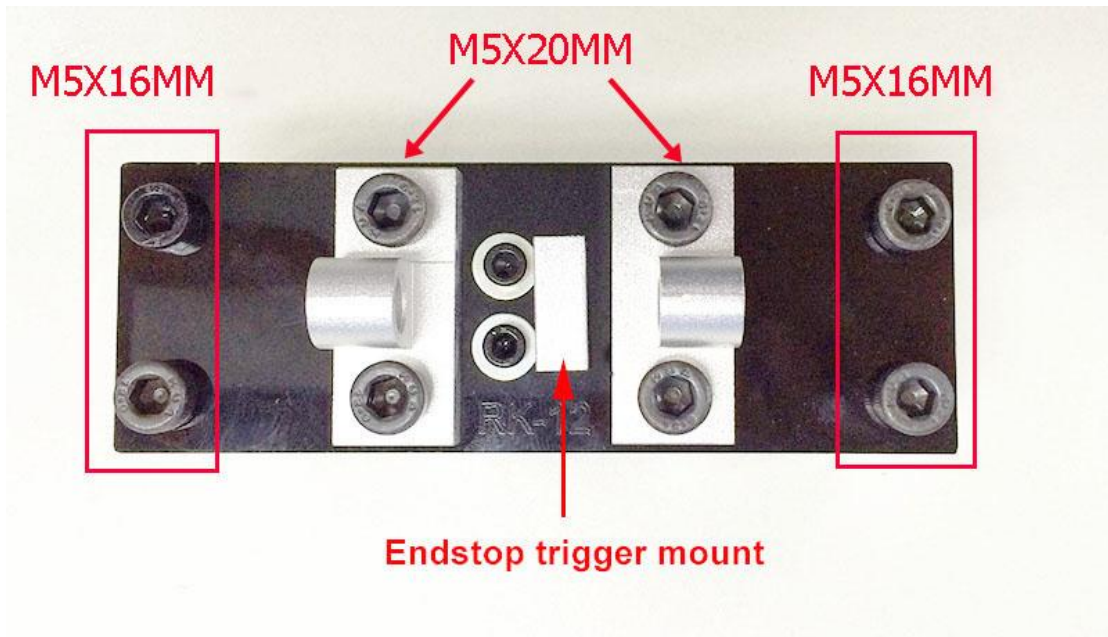

Step 3. Now insert the M3x40mm screw (#23) into the endstop trigger mount with a spring (#29) in between. Here you need to use washers (#5) to correctly complete the assembly.

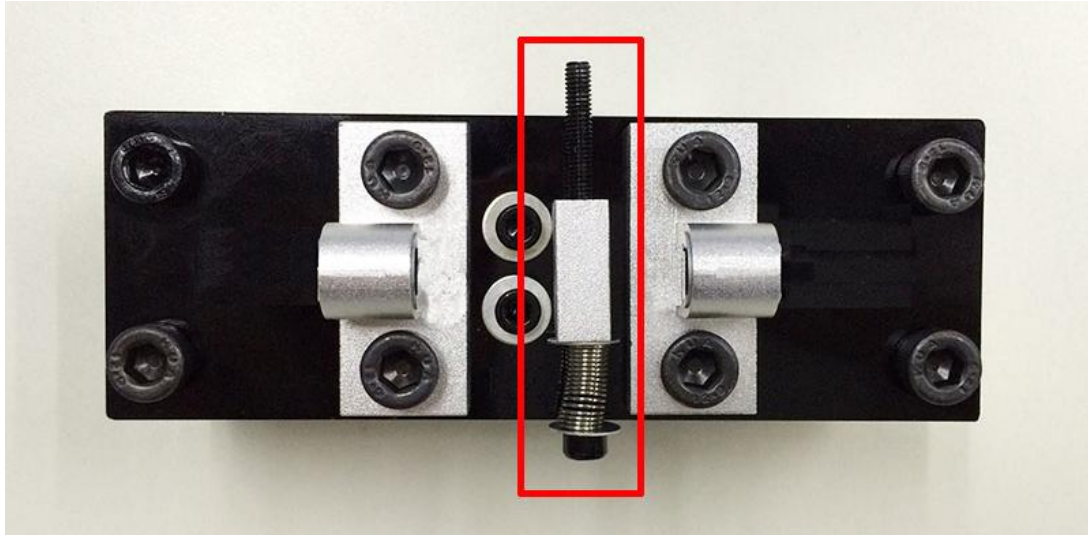

Repeat the steps for the remaining two carriages. When you have completed these all three carriages should be exactly the same and look as in this picture:

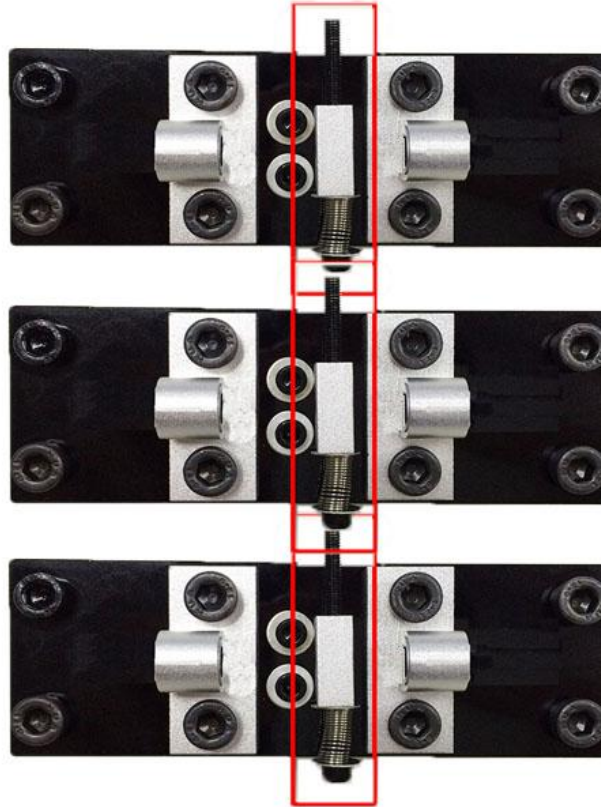

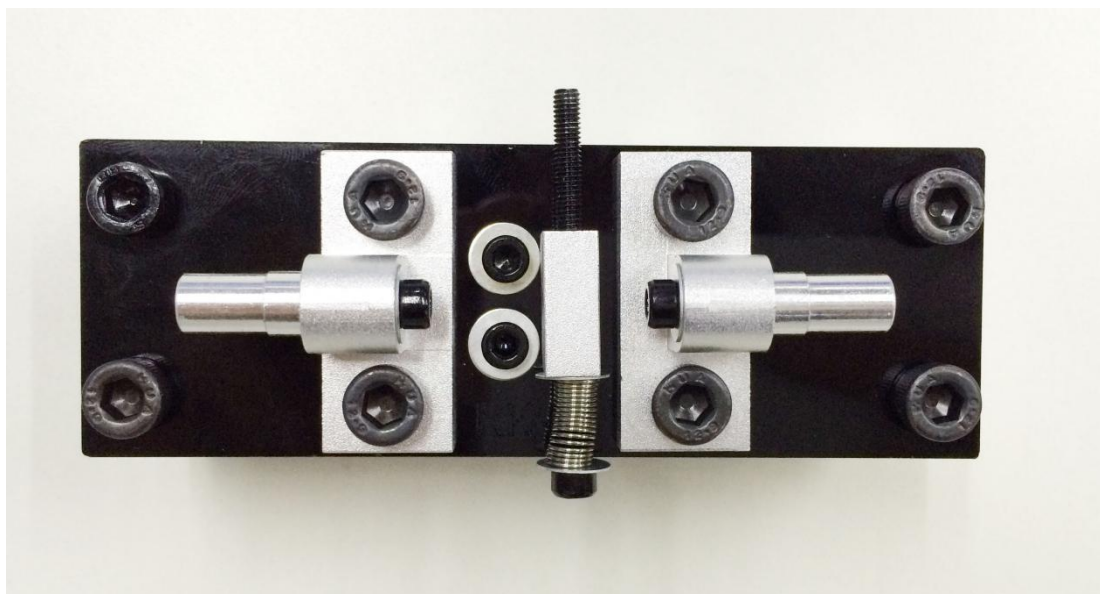

Step 4. Finally insert the rod-end bearing holder (#3) into the diagonal rod joint (#M7) fixing it place with a M3x8mm screw (#18) and M3 washer (#5). Repeat the step for the other 2 carriages.





[Videos](#)

4 Assemble the print platform

4.1 mount the fan

Name	Part #	Qty.	Picture
Spider	#M1	1	
Fan (30x30x10)	#47	1	
Fan mount	#M2	1	

M3 x 16 screw	#20	2	
M3 x20 screw	#21	2	
M3 washer	#5	2	

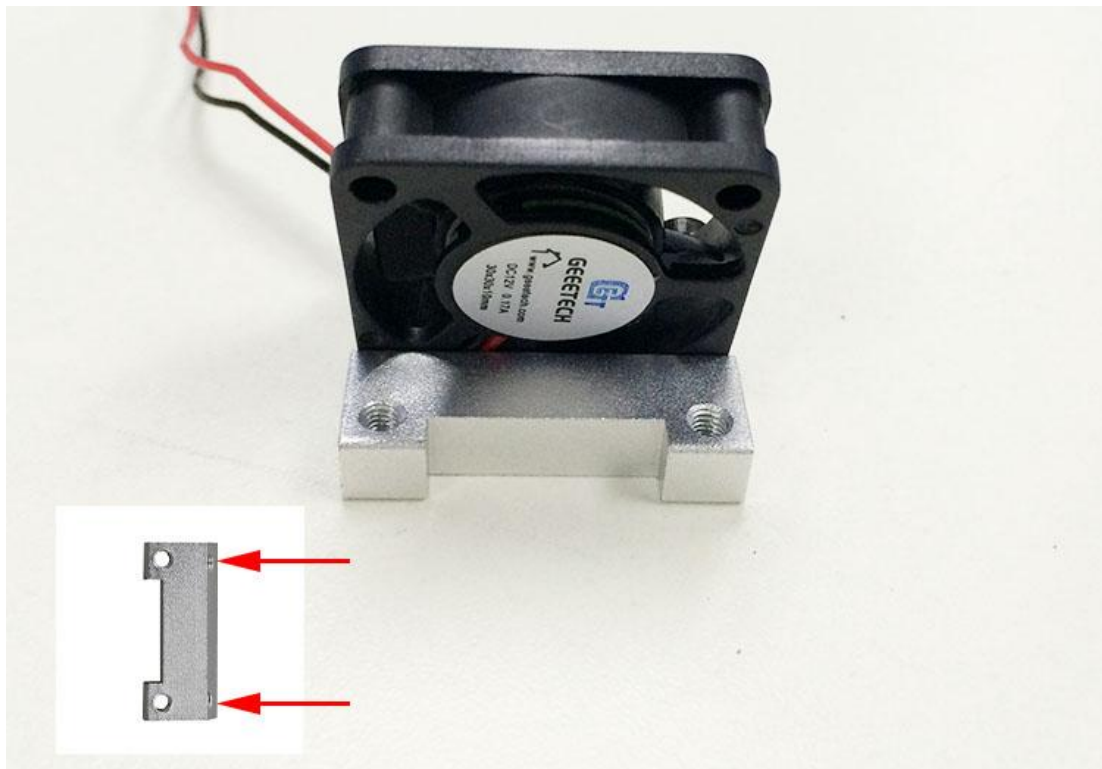

Step 1. Mount the fan (#47) on to the angled (slanted) face of the fan mount (M2) with 2 M3x 20 screws (#21) and M3 washers (#5).

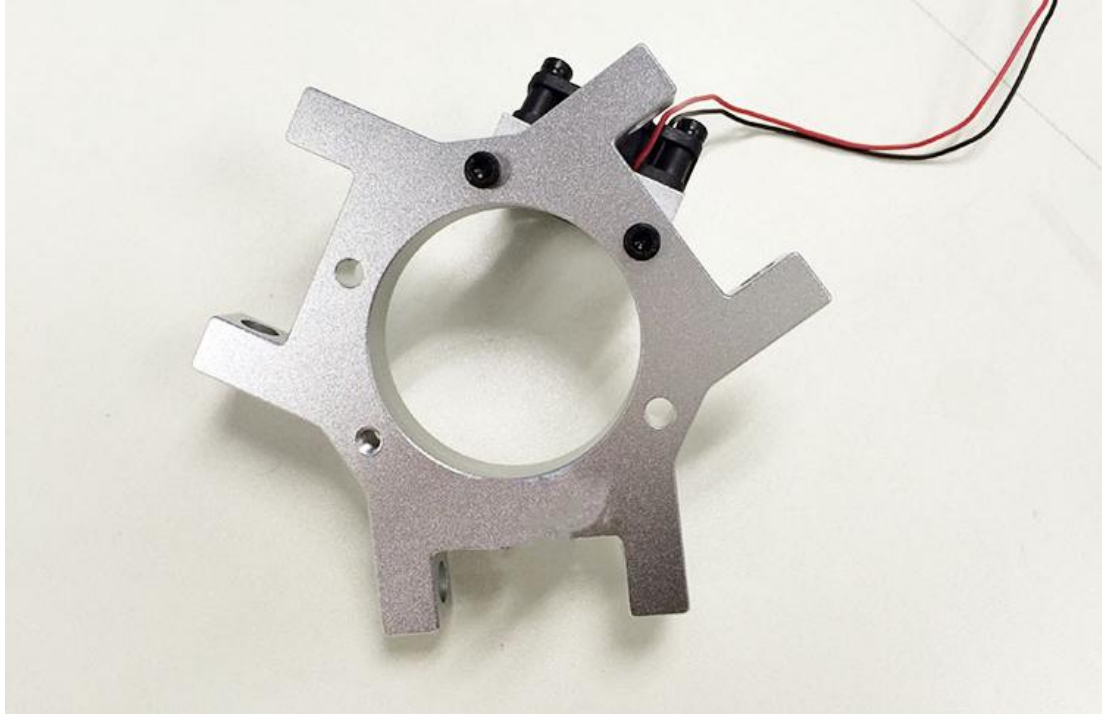

Step 2. Mount the assembled fan mount on the spider (#M1) with 2 M3 x16mm screws (#20).





4.2 Mount the Probe mount

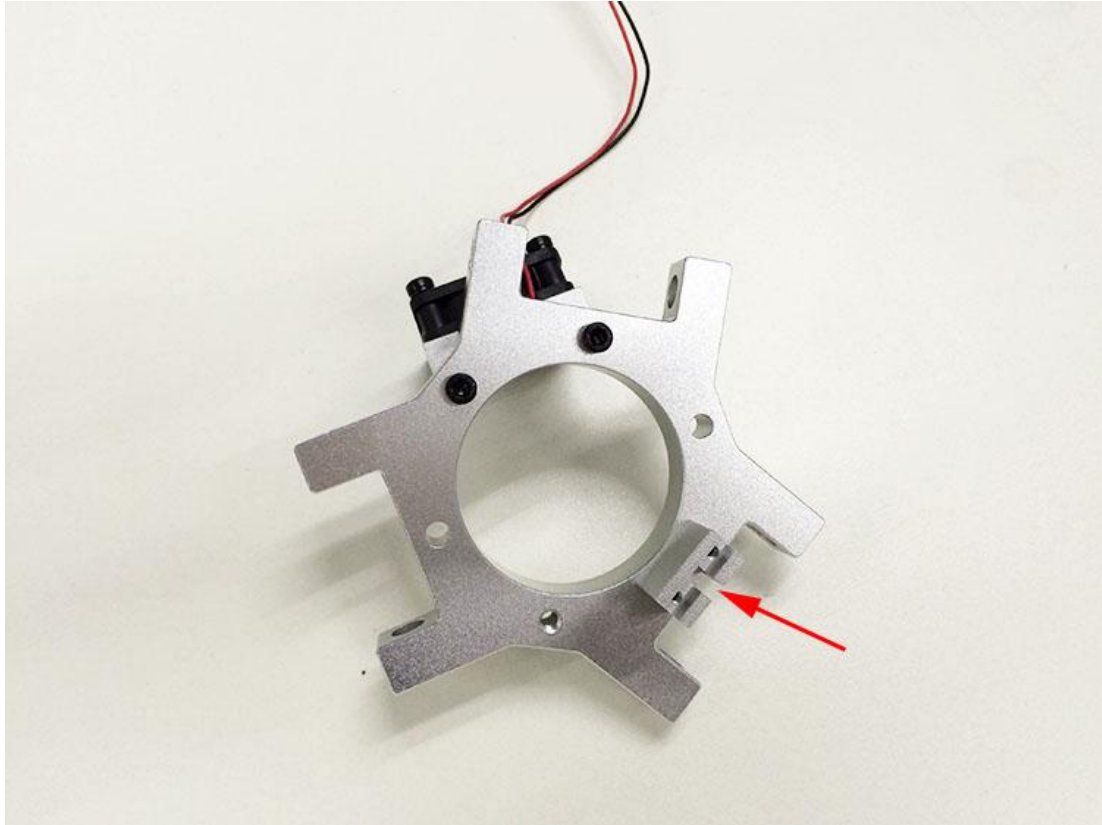

Name	Part #	Qty.	Picture
Probe mount	#M4	1	
M2.5 x 16 screw	#17	2	

Step 1. Mount the probe mount (#M4) on the spider (#M1) with 2 M2.5 x16mm screws (#17). *Taking note that the screws (#M17) are inserted from the underside of the spider (#M1) fixing the probe mount (#M4) to the top side of the spider (#M1).



4.3 Mount the rod-end bearing holder and diagonal rod

Name	Part #	Qty.	Picture
Diagonal Rod	#4	6	
rod-end bearing holder	#3	6	

Round head screw with pad	#15	6	
M3 washer	#5	6	
M3 x 8 screw	#18	6	



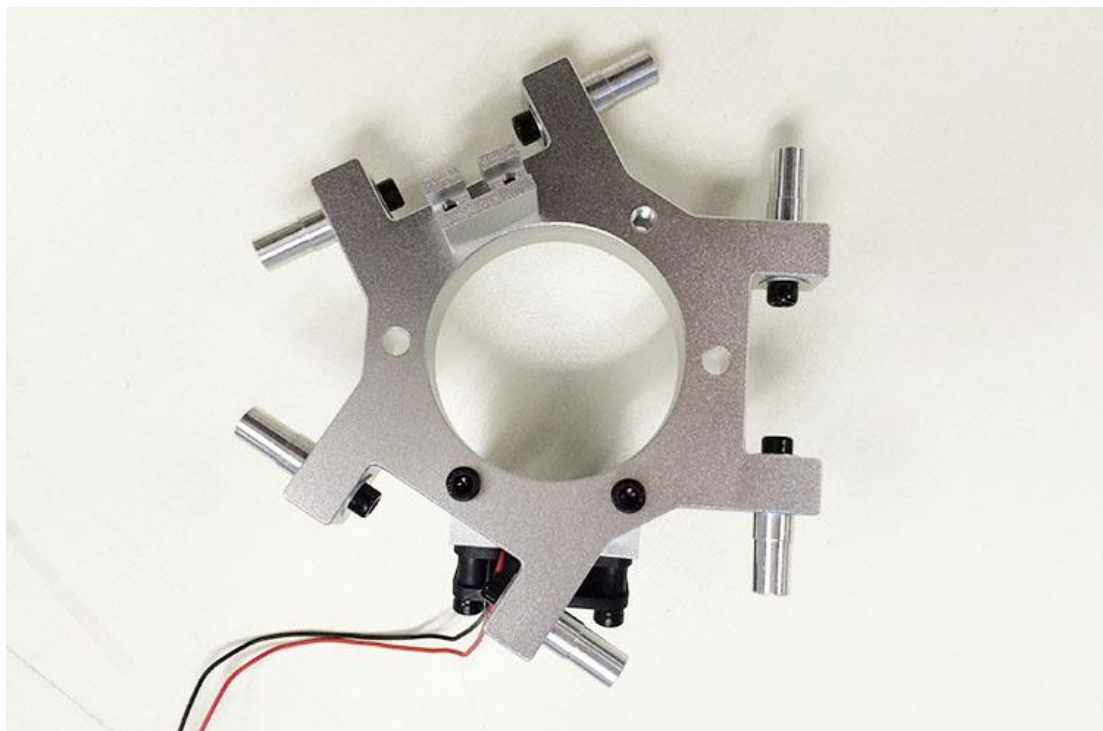

Step 1. Insert the rod-end bearing holder (#3) into the diagonal rod joint location of the spider (#M1), fix it in place with M3x8mm screw (18) and M3 washer (#5).

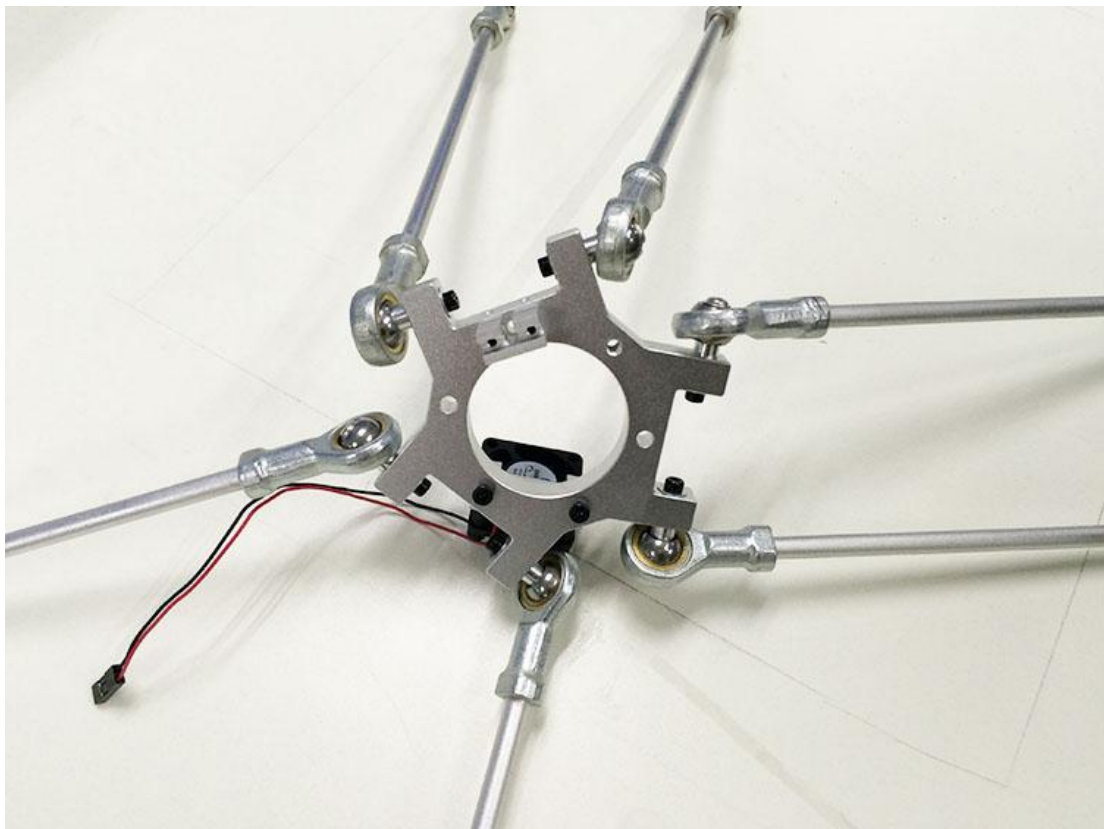
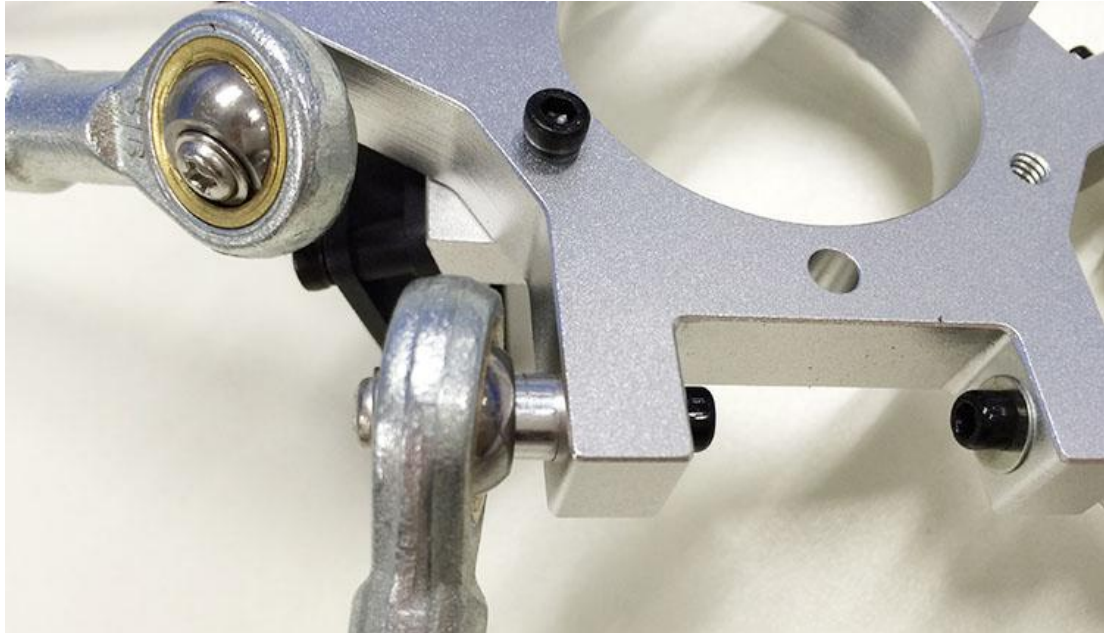

Step 2. Slide the diagonal rod (#4) on to the rod-end bearing holder (#3) and fix it in place with a round head screw with pad (#15).



4.4. Mount the endstop and the probe.

Name	Part #	Qty.	Picture
Endstop	#44	1	
Probe	#43	1	
Spring(3.5*30)	#29	1	
Probe Lock ring	#M3	1	
M2.5 x 8 screw	#16	2	

Step 1. Mount an endstop (#44) on to the spider (#M1) at the screw hole located adjacent to the probe mount (#M4) with 2 M2.5 x 8 screws (#16).

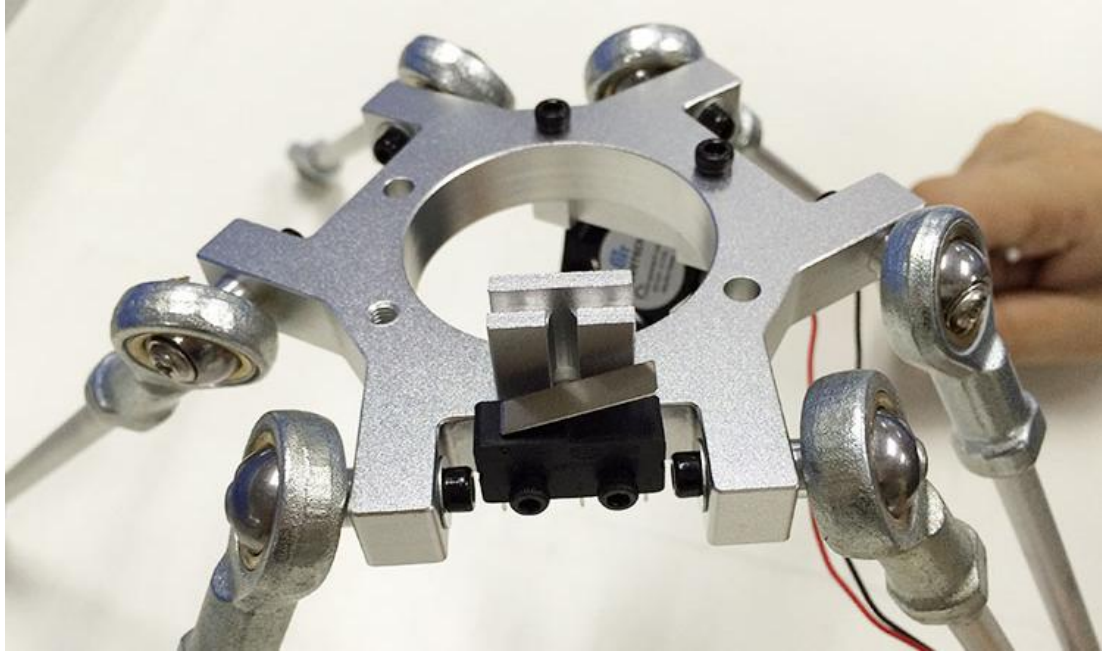

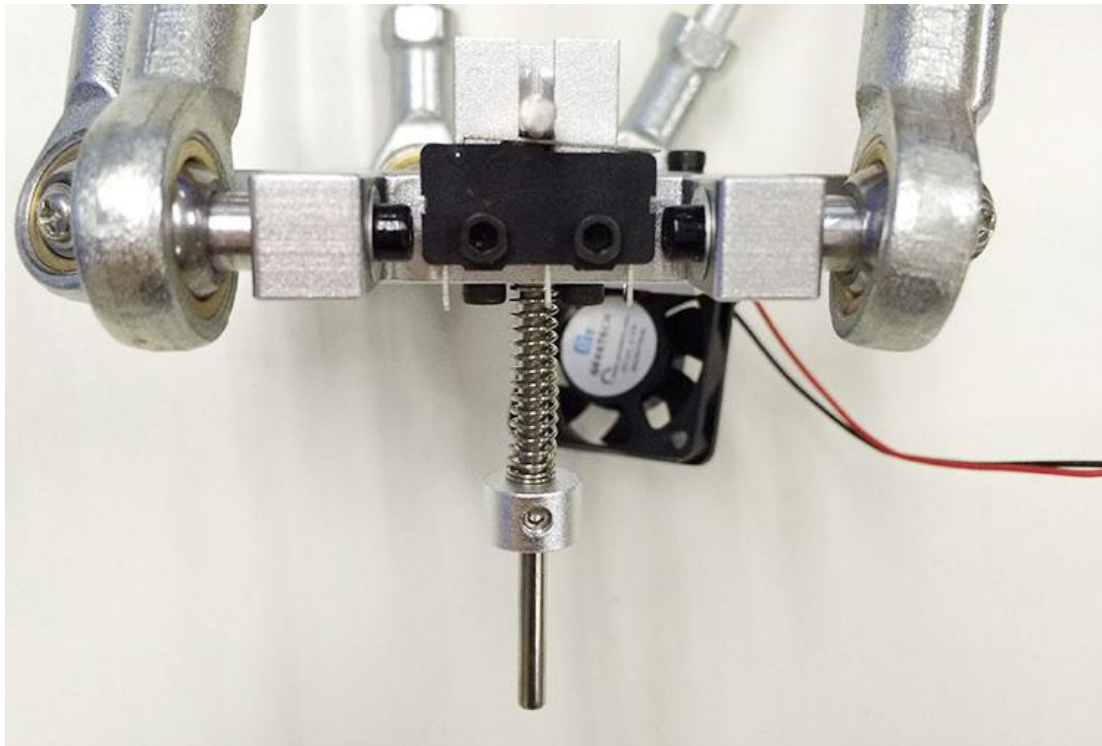

Step 2. Insert the probe (#43) into the probe mount (#M4), slide on the provided spring (#29) and lock it in place with the lock ring (#M3).

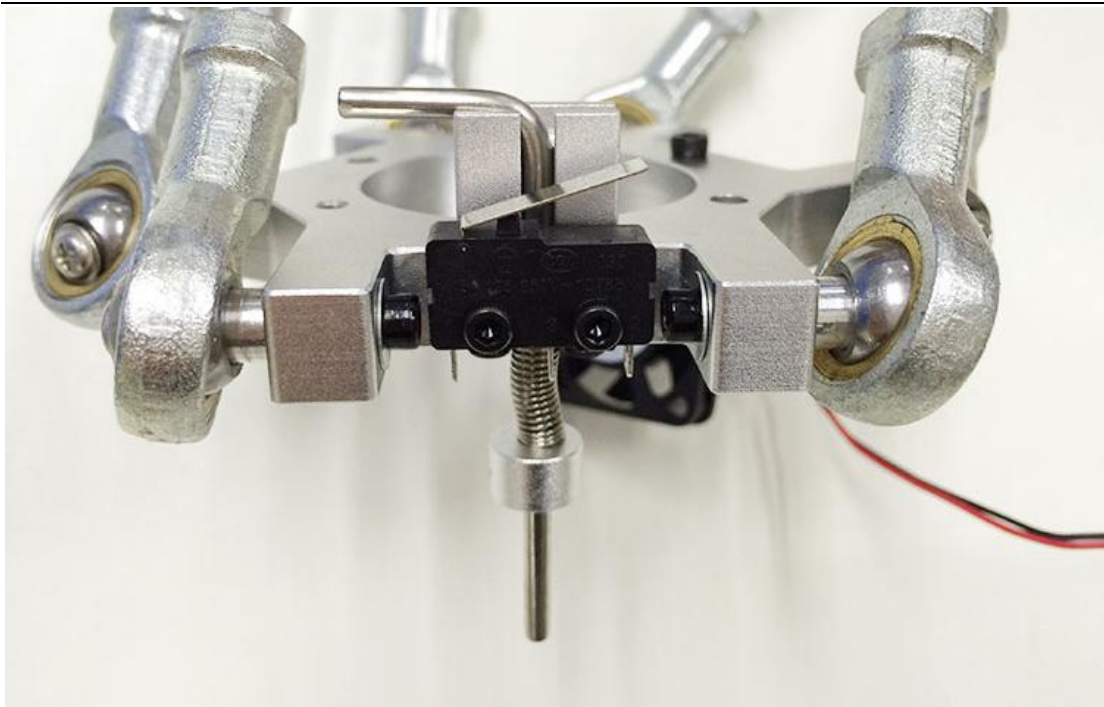



4.5 Mount the hotend.

Name	Part #	Qty.	Picture
Hotend	#57	1	
M4 x 16 screw	#25	2	

Step 1. Mount the hotend (#57) on the now assembled spider (#M1) with 2 M4 x 16 screws (#25).

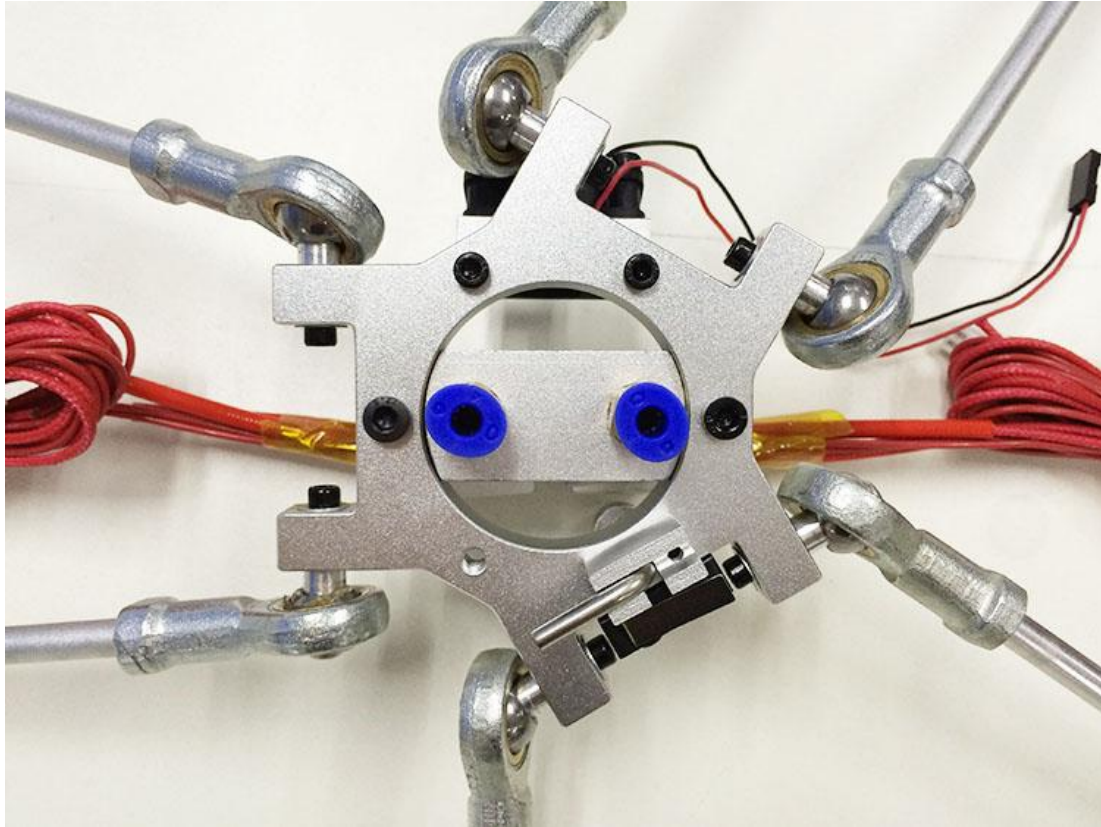

**Note:* Mounting of the single and double hot-ends are done exactly the same way.



[Videos](#)

5 Mount the smooth rods

Name	Part #	Qty.	Picture
Smooth Rod	#1	6	

M4 x 8 Screw	#24	6	
M8 Washers	#8	6	
M4 washer	#6	6	

Step 1. Slide a M8 washer (#8) on to an end of the smooth rod (#1). Insert that end of the rod (#1) into one of the holes located on the tower of base plate (#A1).

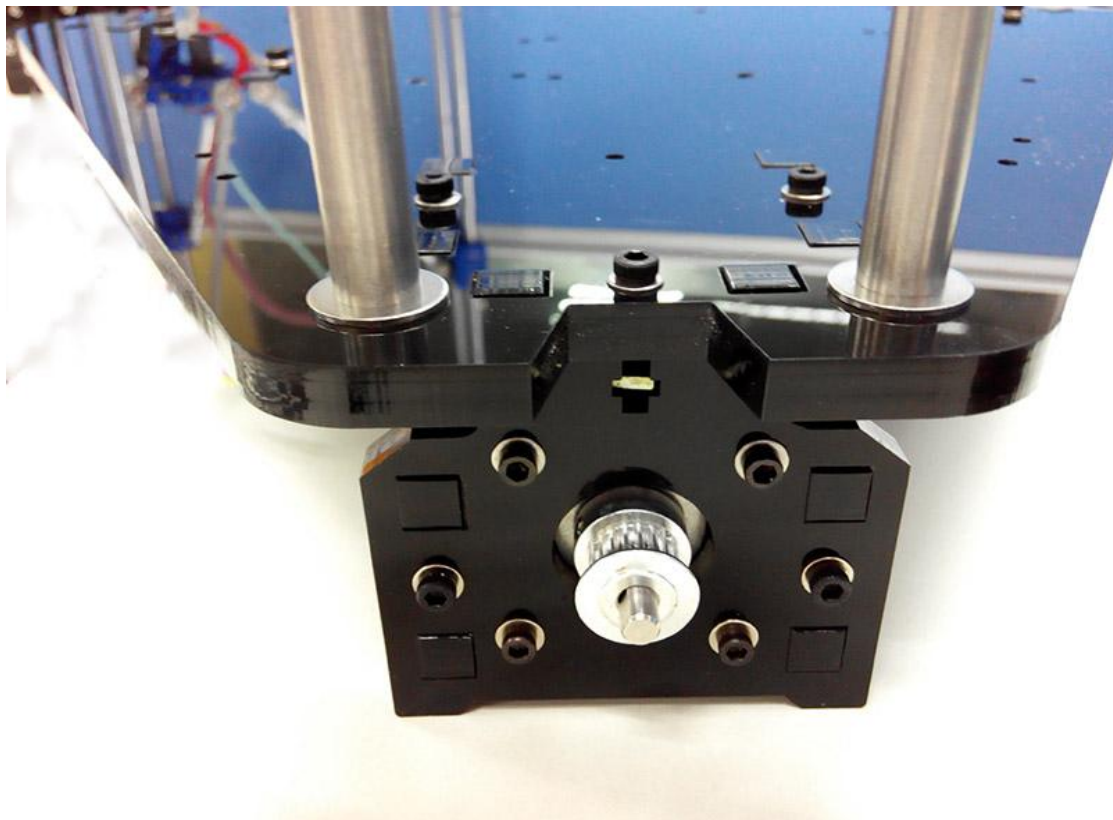

Step 2. Fix the rod (#1) in place with M4 washer (#4) and M4x8 screw (#24).

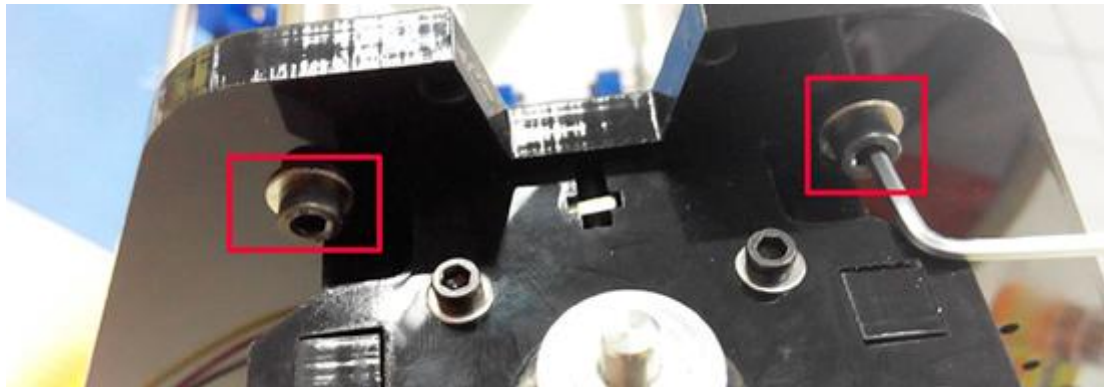



Step 2. Repeat this step for the remaining 5 rods (#1).



[Videos](#)

6 Mount the carriage and the top plate

Name	Part #	Qty.	Picture
M4 x 8 Screw	#24	6	
M8 Washers	#8	6	
M4 washer	#6	6	

Step 1. Slide the carriages down the smooth rods (#1) pairing one carriage with each set of 2 smooth rods (#1). You should now have the beginnings of three towers (X, Y and Z).

*Note: At this point it may be a good opportunity to check that the carriage endstop screws (#23) actually connect with the endstops (#44). Align the top place (#A1) on to the top of the rods (#1) and check that the endstops are correctly orientated.

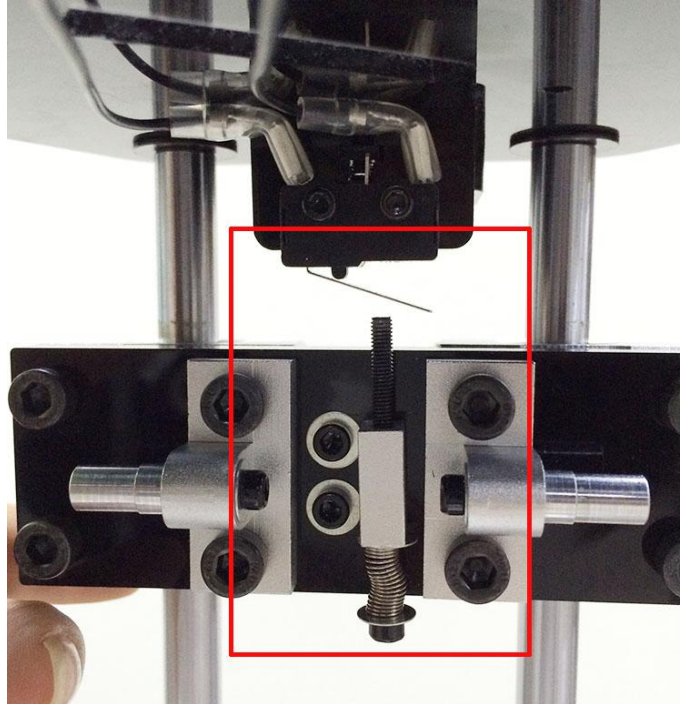

*Note: If you find it difficult to slide the carriage along the rod, or the carriage does not slide smoothly, you can slightly loosen the screws on the difficult linear bearing (#35) to release some alignment pressure with the smooth rod (#1).

Step 2. Slide a M8 washer (#8) on each top of each smooth rod (#1) and then align the top plate (#A1) and smooth rods (#1) until with some pressure the top place (A1) slides on to the three towers. Fix the top place (A1) in place with the M4x 8 screws (#24) and M4 washers (#6).











*Photos with PCS8UU linear bearings in this instruction is the previous version,here we use PCS8UU instead. Picture is just for reference.



[Videos](#)

7 Mount the Belt

7.1 Assemble the drive wheel

Part name	Part #	Qty.	Picture
Drive wheel holder	#33	3	
Drive wheel	#32	3	
R84zz Ball Bearing	#31	6	
M3 x 16mm screw	#20	3	
M4 x 25mm screw	#26	3	
M4 washer	#6	3	
M4 lock nut	#11	3	
wing nut	#12	3	

Step 1. Thread the M3 x 16 screw (#20) through the top hole on the drive wheel holder (#33).



Step 2. Pick up 2 MR84zz ball bearings (#31). Insert 1 MR84zz ball bearings (#31) into both ends of the drive wheel (#32).

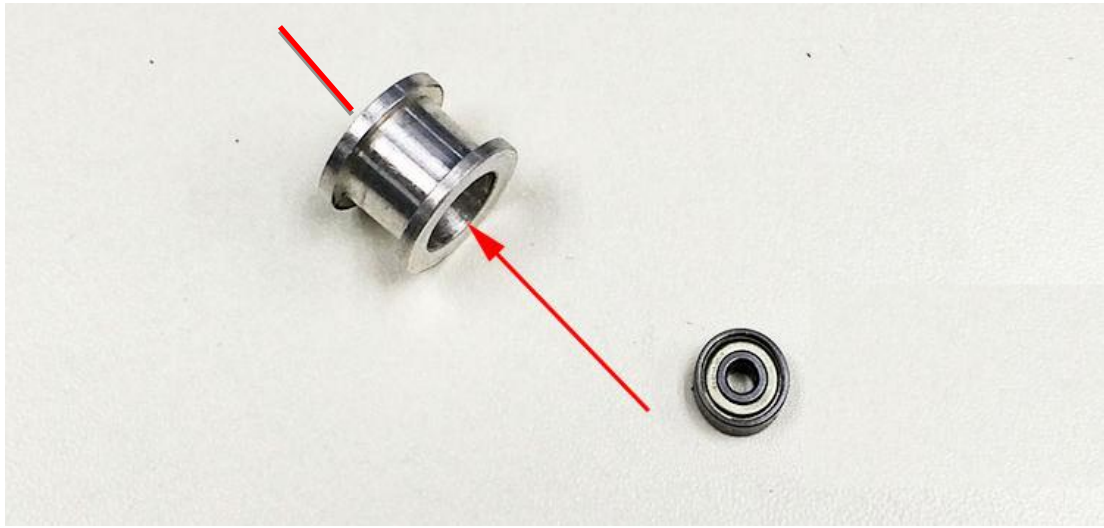

Step 3. Place the drive wheel (#32) in to the drive wheel holder (#33) and fix it in place with an M4 x25 screw (#26) and M4 washer (#6). Lock the other end with a M4 lock nut (#11). You may need a wrench to tighten M4 locking nut (#11).







*Note: Do not screw it too tightly as it may restrict the free movement of the drive wheel. It is important that you leave enough room for the wheel to turn freely.

Repeat these steps to assemble the other two drive wheel assemblies.

Step 4. Fix the drive wheel assembly loosely on the top plate (#A1) with a wing nut (#12).

Repeat these steps to mount the other two drive wheel assemblies to the top plate (#A1).

7.2 Add the belt

Name	Part #	Qty.	Picture
Timing Belt	#36	3	
M3 x8 Screw	#18	6	

M3 washer	#5	6	
-----------	----	---	---

Step 1. Thread the timing belt (#36) through the drive wheel with the pitched side in direct contact with the drive wheel and the smooth side facing out.

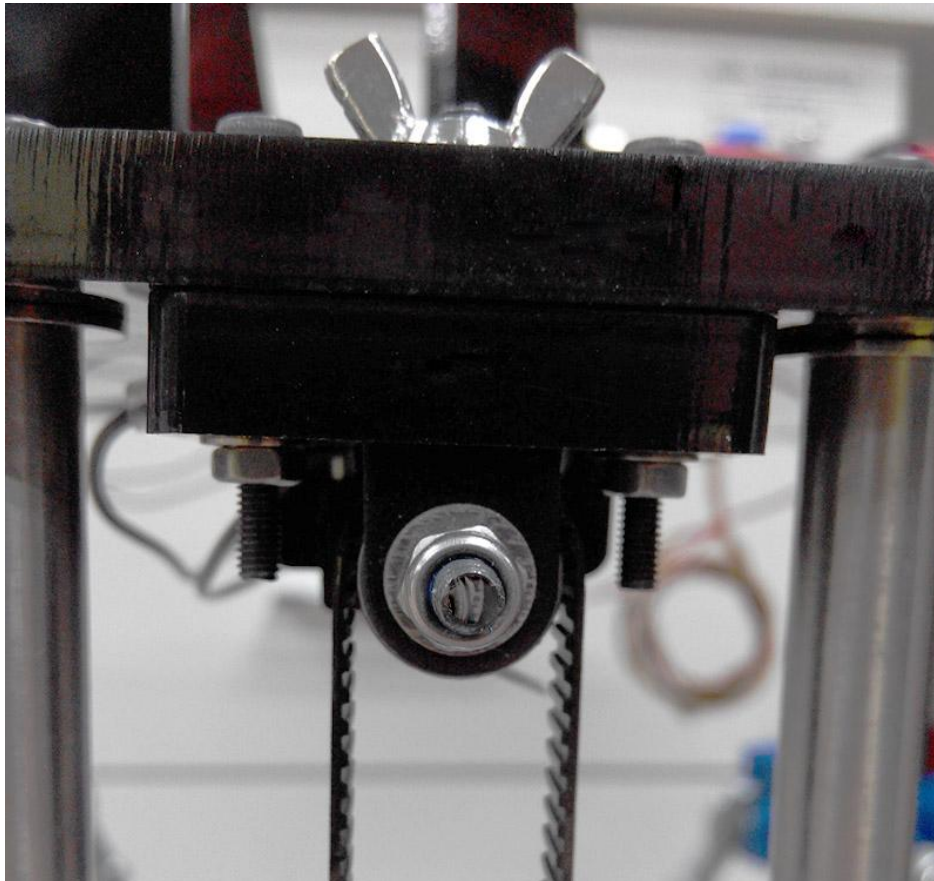

Step 2. Punch a 2-2.5mm hole in to the timing belt (#36) with a leather hole punch or similar (not supplied).

Step 3. Fix one end of the timing belt (#36) to the belt mount (#M5) with a M3x8mm screw (#18) and M3 washer (#5).

Step 4. Guide the timing belt (#36) around the motor pulley (#34) and back up to the underside of the belt mount (#M5). Mark the location of the new hole to be punched to allow the timing belt (#36) to be fixed to the belt mount (#M5). Trim the timing belt (#36), punch the hole and fix it to the belt mount (#M5) with a M3x8mm screw (#18) and M3 washer (#5).

*Note: Before you cut the belt, be sure that you have the correct length, it should be about 110cm long in total.

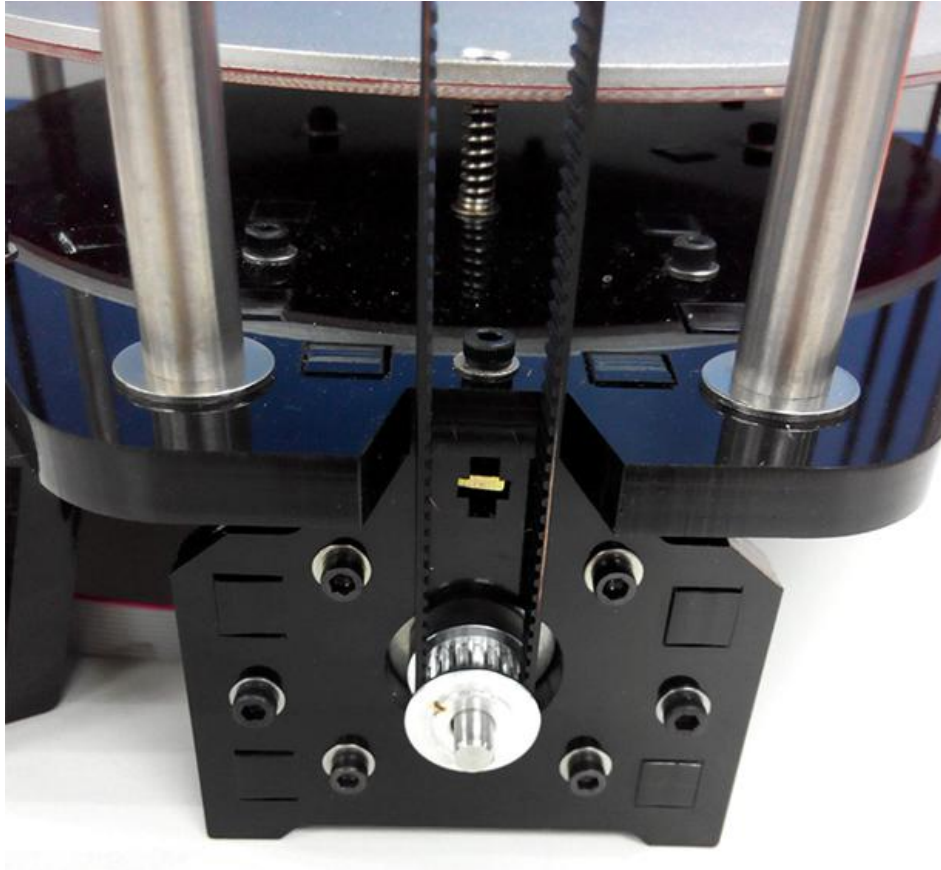

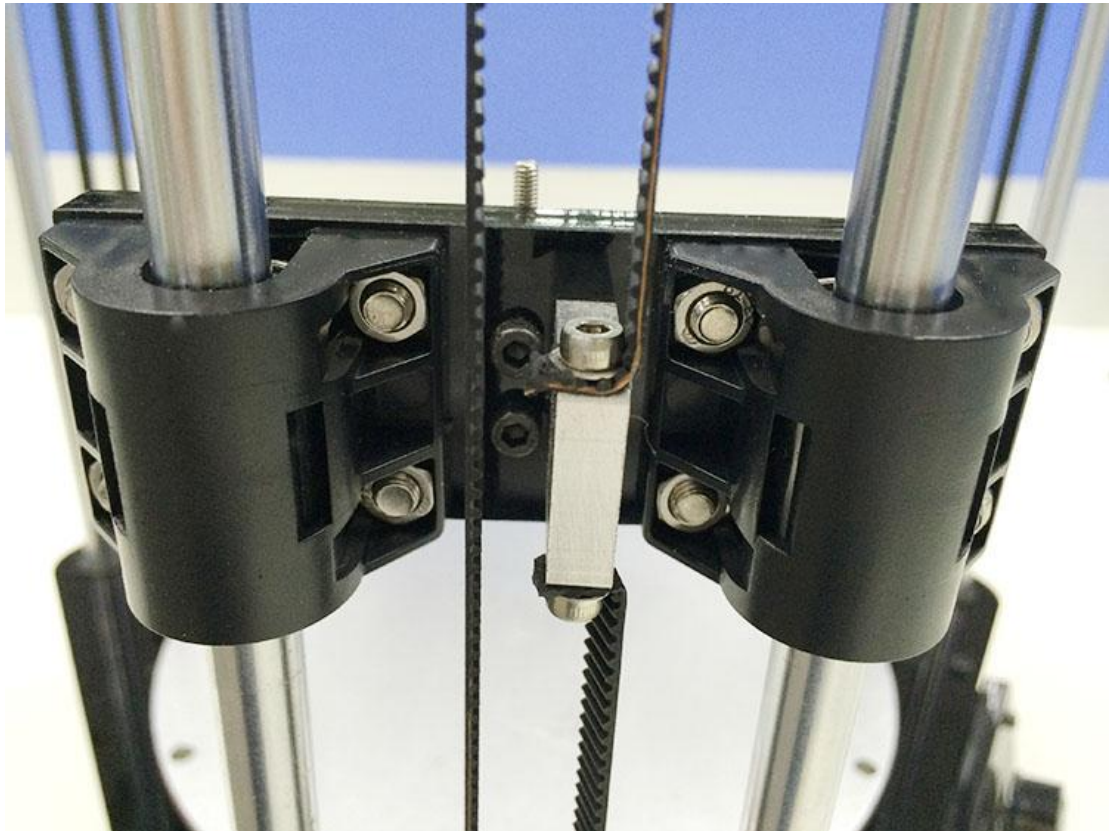

Step 5. Tighten the wing nut (#12) to to reduce the slack in the timing belt (#36).

Repeat the above steps for the other 2 timing belts (#36).

[Videos](#)

8 Connect the Diagonal Rod to the carriage

Name	Part #	Qty.	Picture
Round head screw with pad	#15	6	

- Step 1. Place the print head assembly on to the building platform (#M8) aligning it so then the end stop (#44) and probe (#43) are facing the “X” tower.
- Step 2. Working with the “X” axis first, slide the diagonal rod (#4) on to the on the rod-end bearing holder located on the assembled print assembly, fixing it on with a round head screw with pad (#15).
- Step 3. Fix the other end of the diagonal rod (#4) to the carriage located on the “X axis” tower with a round head screw with pad (#15).



*Note. The auto-leveling device is towards the X tower, as shown in the following picture:

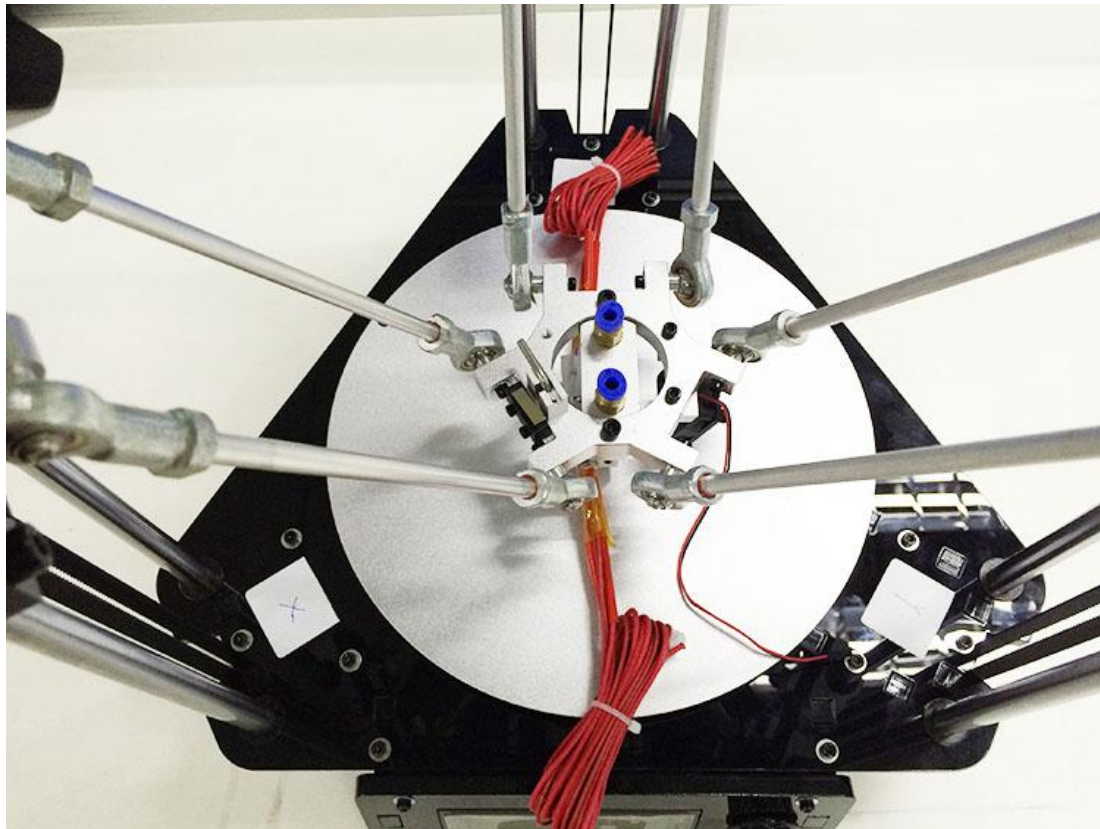



Fix the remaining diagonal rods (#4) to the carriages with a round head screw with pad (#15).

[Videos](#)

9 Mount the extruder

We shall be using the dual extruder as the example in this assembly guide as most of the steps are very similar to the single extruder model.

Name	Part #	Qty.	Picture
Extruder	#56A/B	2	
M4 x 12 screw	#24A	8	

Note: In the case of the dual extruder model, ensure that the release handles on the extruder (#56A/B) are positioned as per the photo below otherwise they will not align with the screw holes in the top plate (#A1).

Step 1. Find out the locating holes on the top plate (#A1) and mount the the extruder (#56) and from the underside of the top plate (#A1), fix in place with 4 M4x 12 (#24A) screws..

Repeat this step for the other extruder (#56).

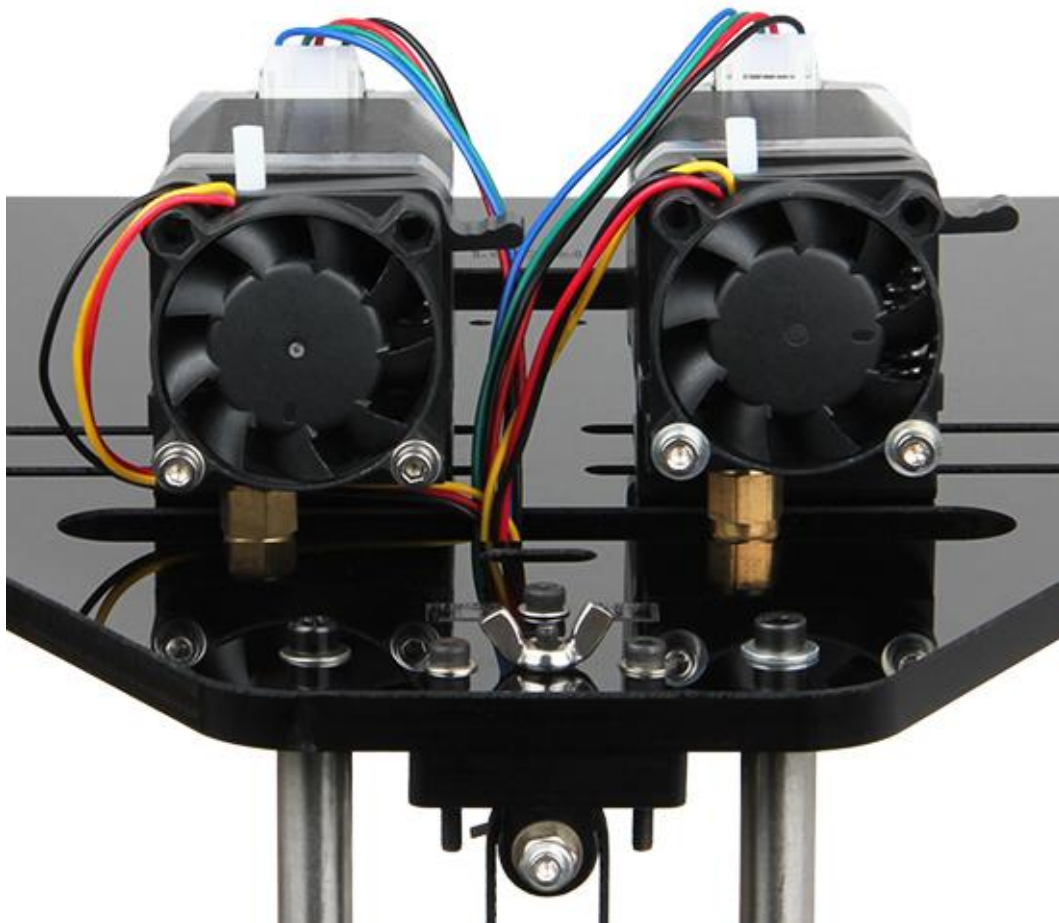

Dual extruder

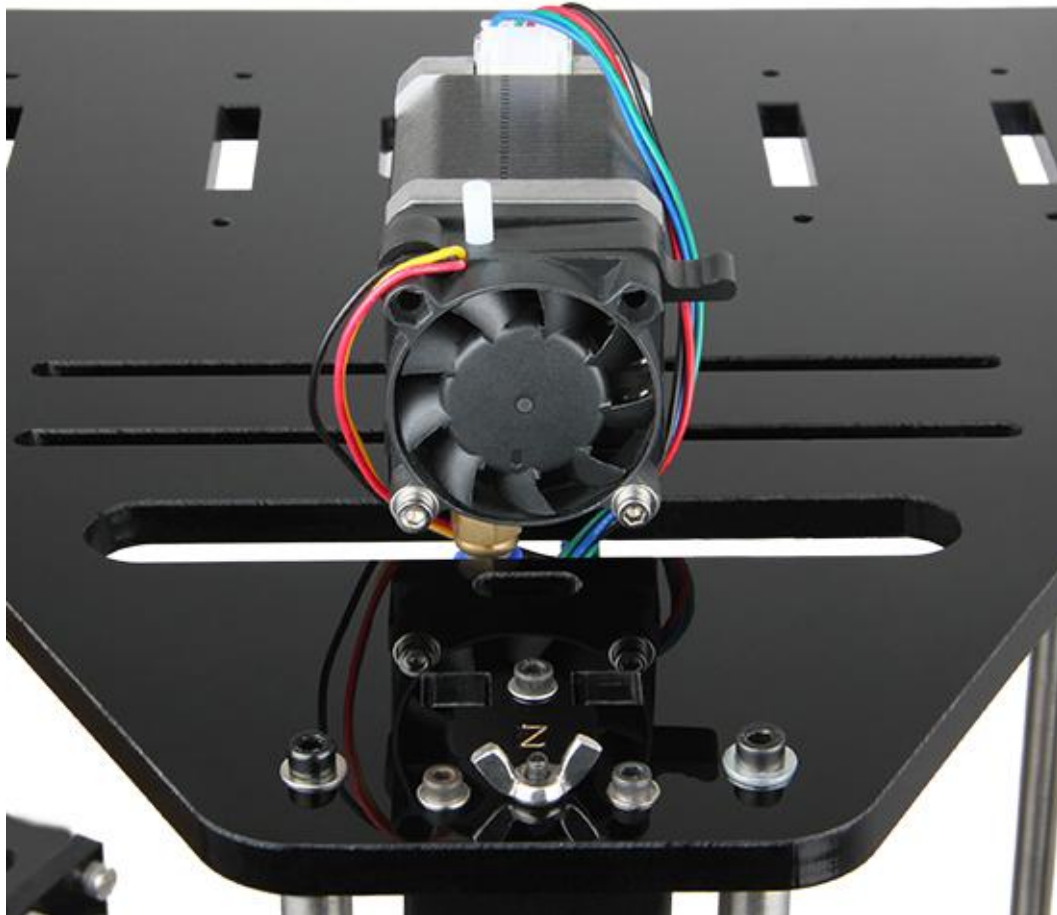



Single extruder

[Videos](#)

10 Mount the filament holder

Note: If you prefer, this step can be left for the very end of the assembly and configuration process.

Name	Part #	Qty.	Picture

Spool holder Side panel	#A10	1	
Spool holder Side panel	#A11	1	
M3x16 screw	#20	4	
Square nut	#13	4	
locking ring	#30	2	

- Step 1. Fit the spool holder side panel (#A10) in to the locating holes on the top plate (#A1) and fix in place with M3x16 screw (#20), M3 square nut (#13) and washer (#5).
- Step 2. Repeat the previous step with the other spool holder side panel (#A10) fixing in place with M3x16 screw (#20), M3 square nut (#13) and washer (#5).
- Step 3. Slide the spool holder round rod (#2) through the holes provided in the spool holder side panels (#A10 & #A11) and lock the spool holder rod (#2) in place with the locking rings (#30). You can finish this step later when you start printing.

EXAMPLE 1: G2



EXAMPLE 2: G2S



Note: For this dual filament spool, you need to use the locking ring to lock the spool on both ends.

[Videos](#)

11 Connect the feeding pipe

Name	Part #	Qty.	Picture
Feeding pipe	#1	1	

Step 1. Plug one end of the feeding pipe (#1) into the push-fitting located at the top of the hot end (identified by the blue plastic ring) and the other end into that of the extruder (#56A/B).

Note: Before connecting the feeding pipe, you need to match the extruder and the hot end. From the viewpoint of back (“Z” tower) the left side extruder is referred to as “extruder 2” and the right one is “extruder 1”.

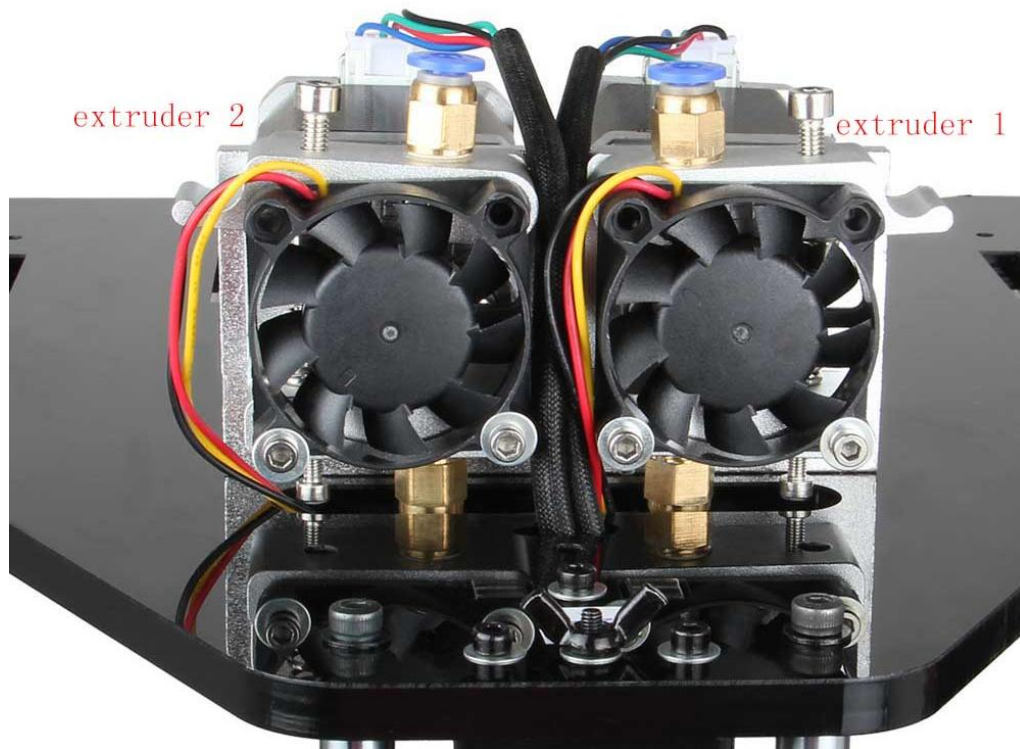

Note: The hot end at the front (nearest the LCD panel) is “extruder 1” and the one behind it (nearest the “Z” tower) is “extruder 2”.

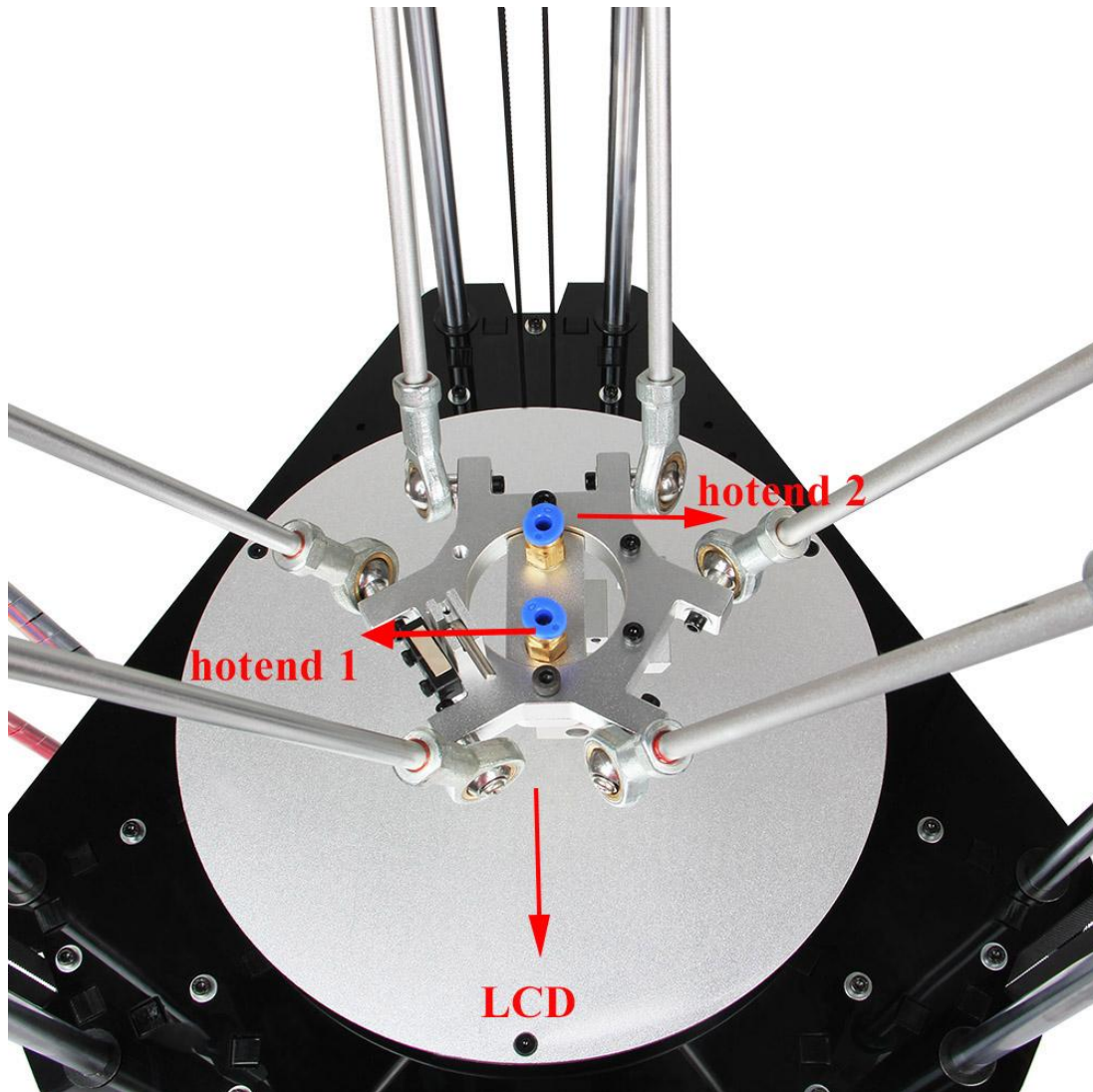

*Note: If you need to pull the tube out, please press the push-in fitting(blue part) while pulling.

12 Wiring

Before you start wiring, please take a look at the wiring schematics.

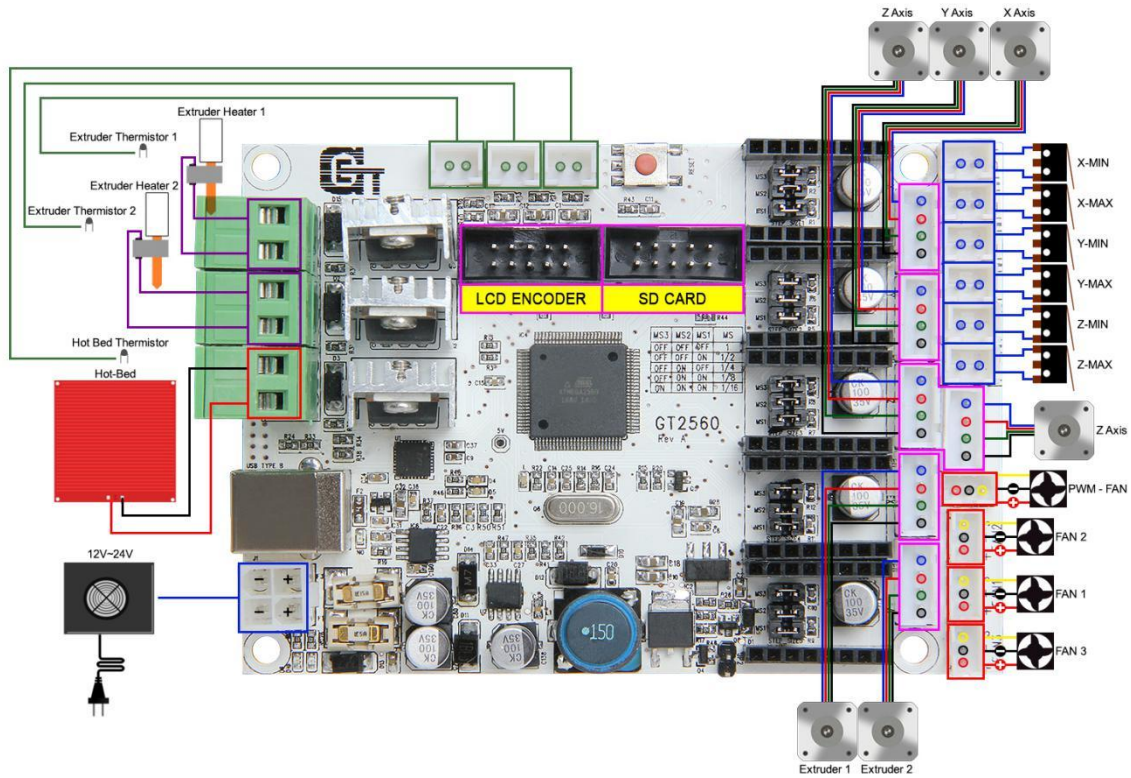

You can see original picture [here](#).

1 Connect wires for motors.

Step 1. Connect wires for X-axis motor.



Step 2. Connect wires for Y-axis motor.

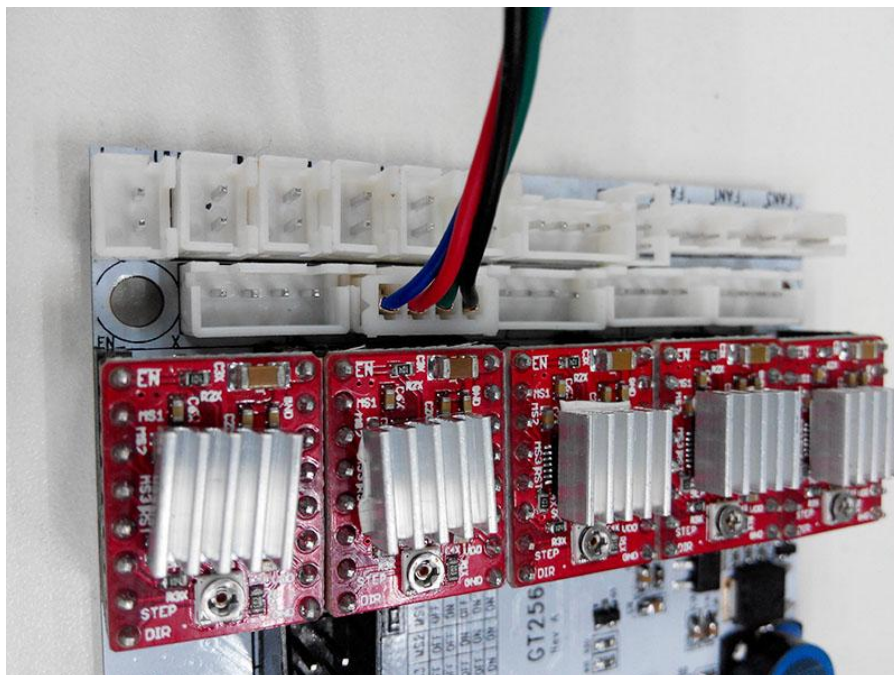

Step 3. Connect wires for Z-axis motor.

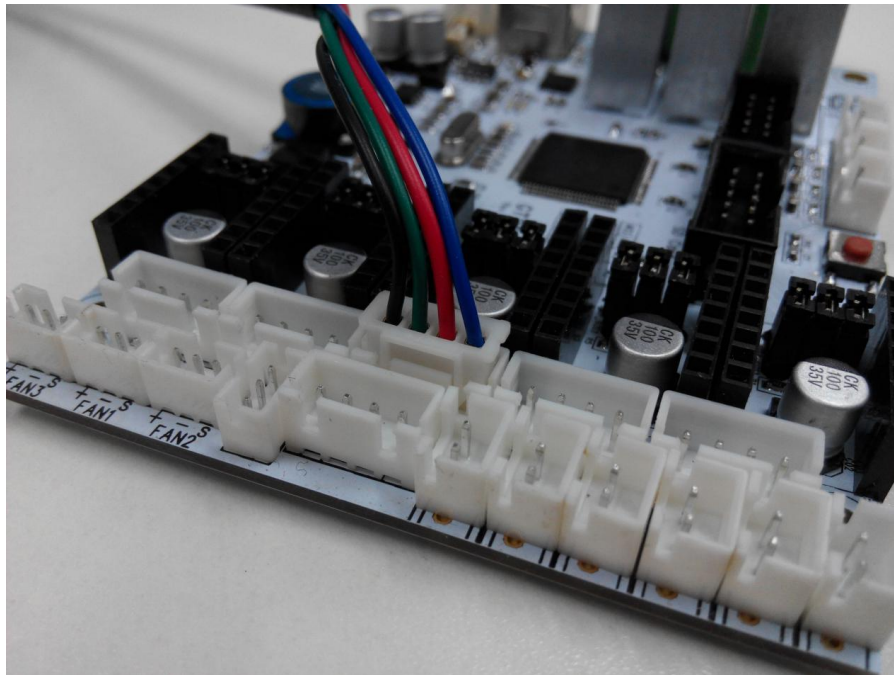

2Connect extruder motor(s)

Step 1. Identify which extruder you are connecting; this connector plug is for “extruder 1” (for dual hot end) or just the extruder (single hot end).

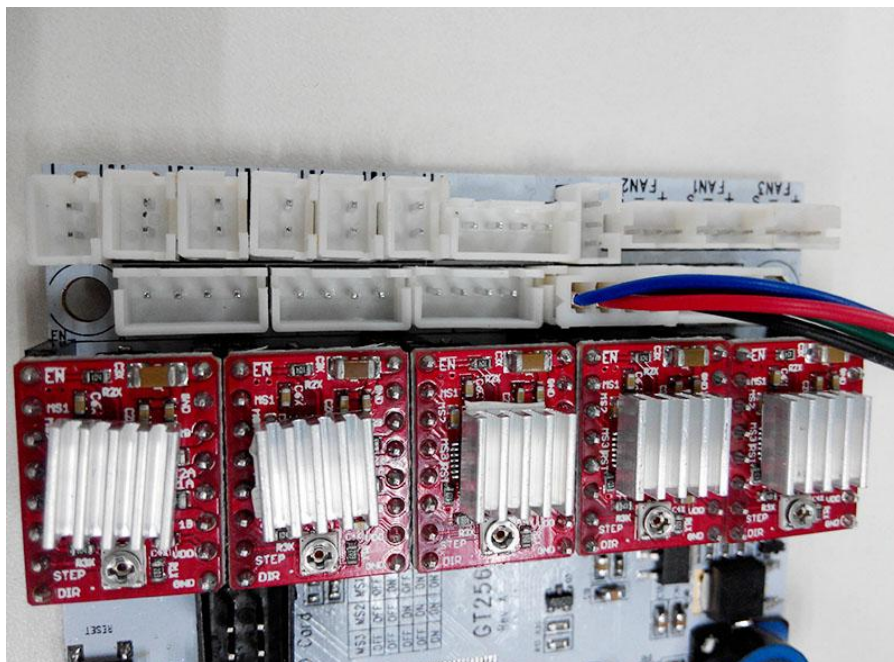

Step 2. Connect “extruder 2” to this connector plug. (FOR G2S PRO)

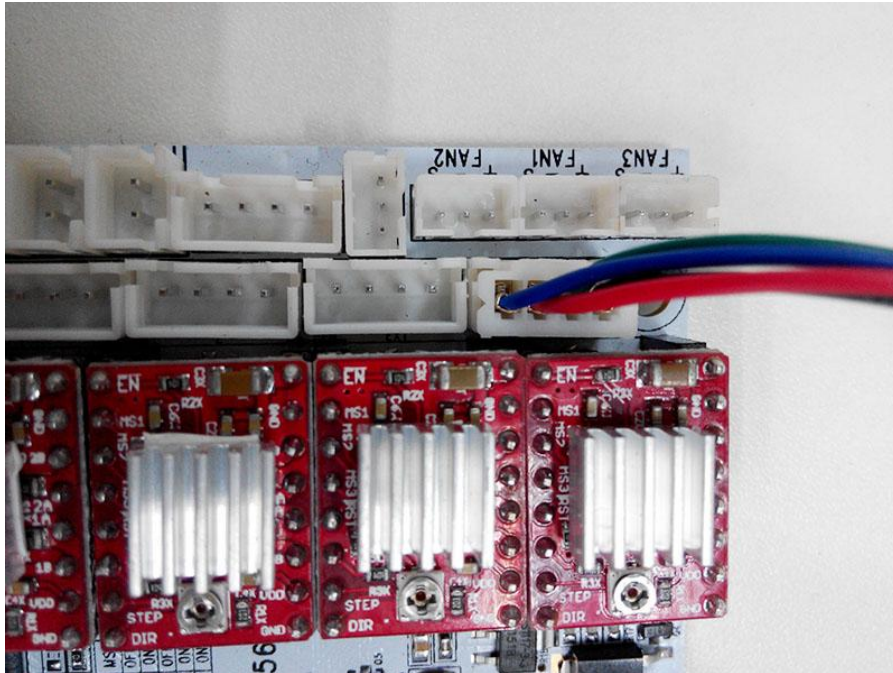

3Heating wires

Note: Heating wires do not have a positive (+) or negative (-) wire, therefore you can safely connect either wire into the connector plug.

Step 1. Loosen the screws on the green connector and insert the wires and re-tighten the connector.

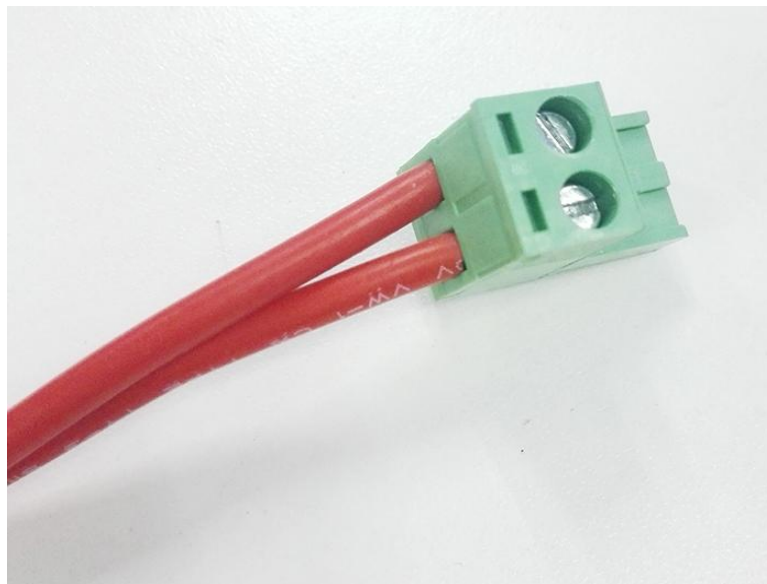
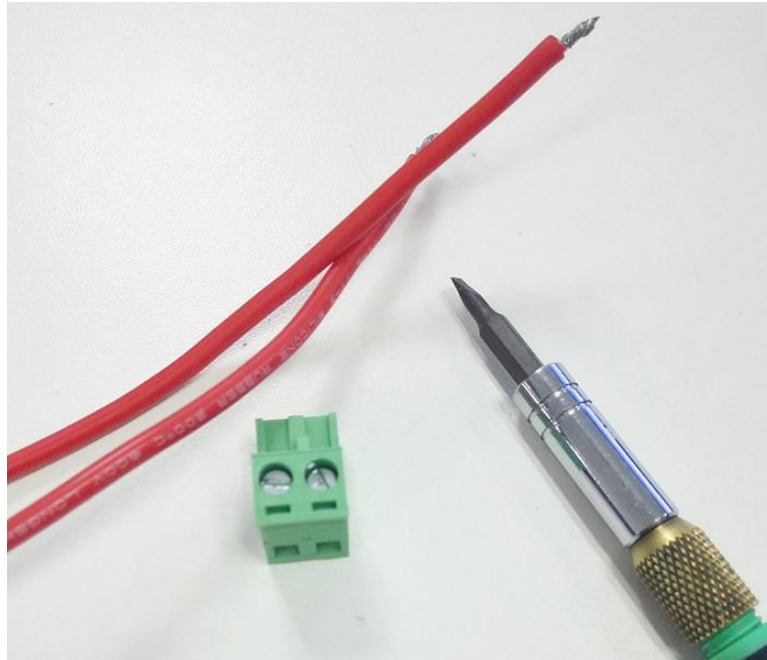

Step 2. Connect heat-bed wires.

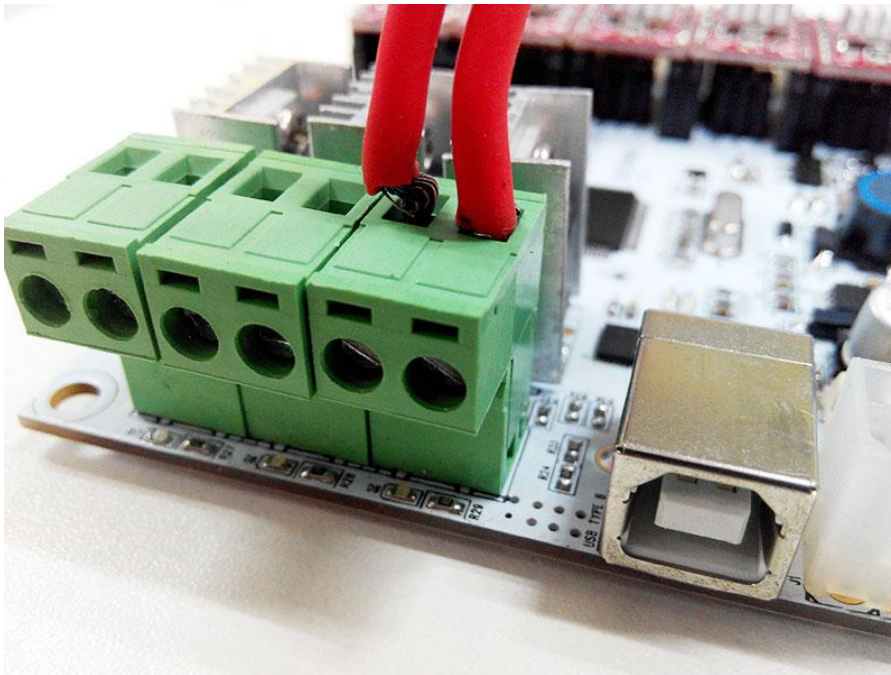

Step 3. Connect “hot end 1” (nearest LCD panel) heating wire.

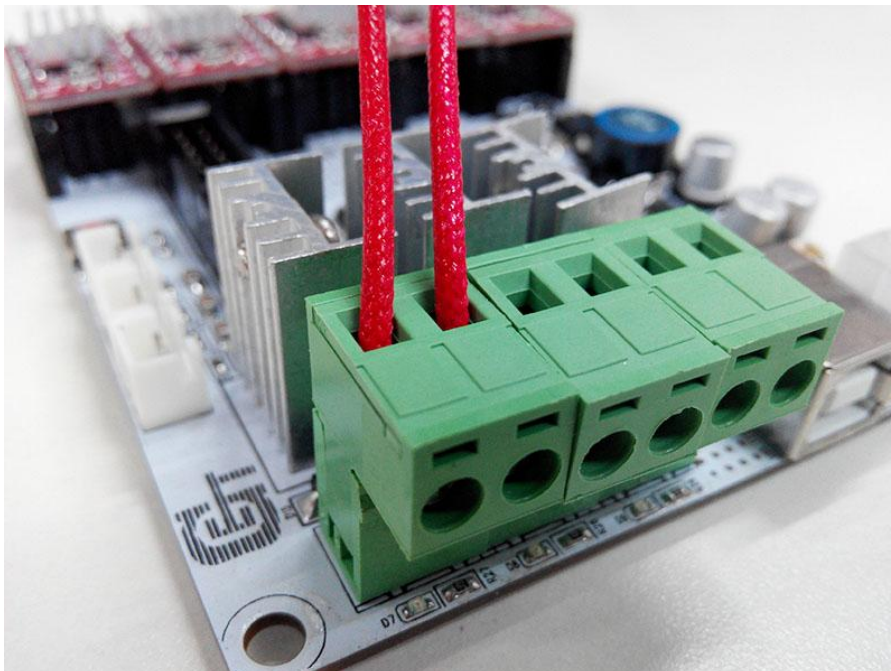

Step 4. Connect “hot end 2” (nearest “Z” tower) heating wire.

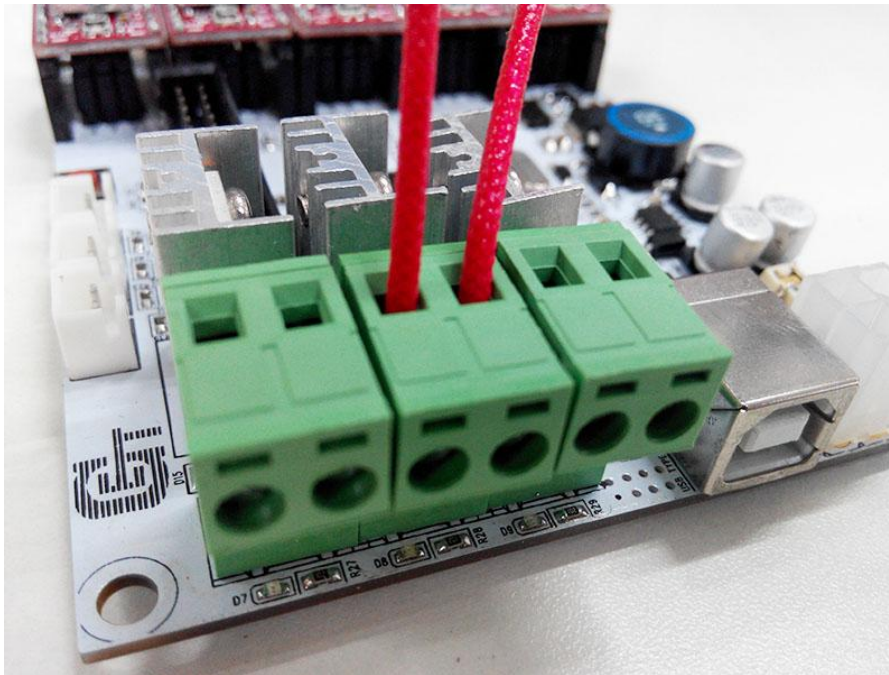

***Note:** Take much care when connecting wires. Do not rush and do not mix up the wires. Take special care not to mix up the wires for heating and the thermistors.

4Connect wires for thermistor.

Step 1. Connect the thermistor from to the heat-bed to the left connector plug.

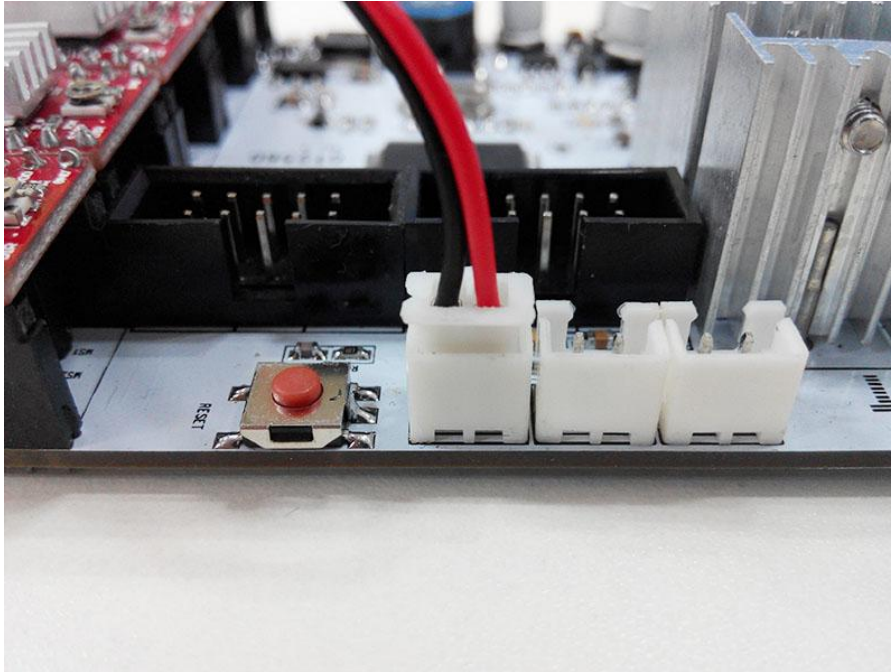

Step 2. Connect the thermistor from “hot end 1” to the right connector plug.

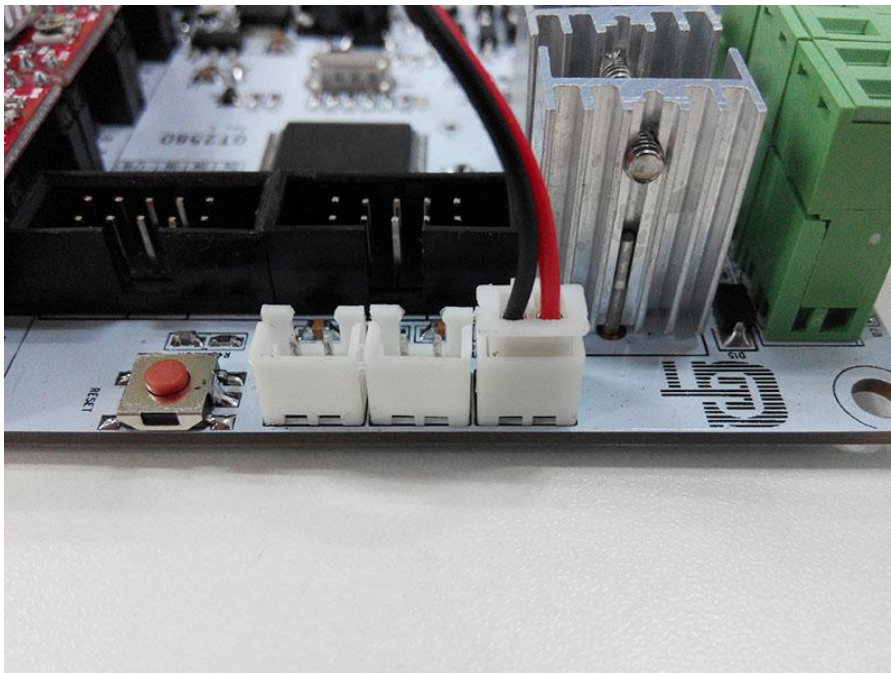

Step 3. Connect the thermistor from “hot end 2” to the middle connector plug.

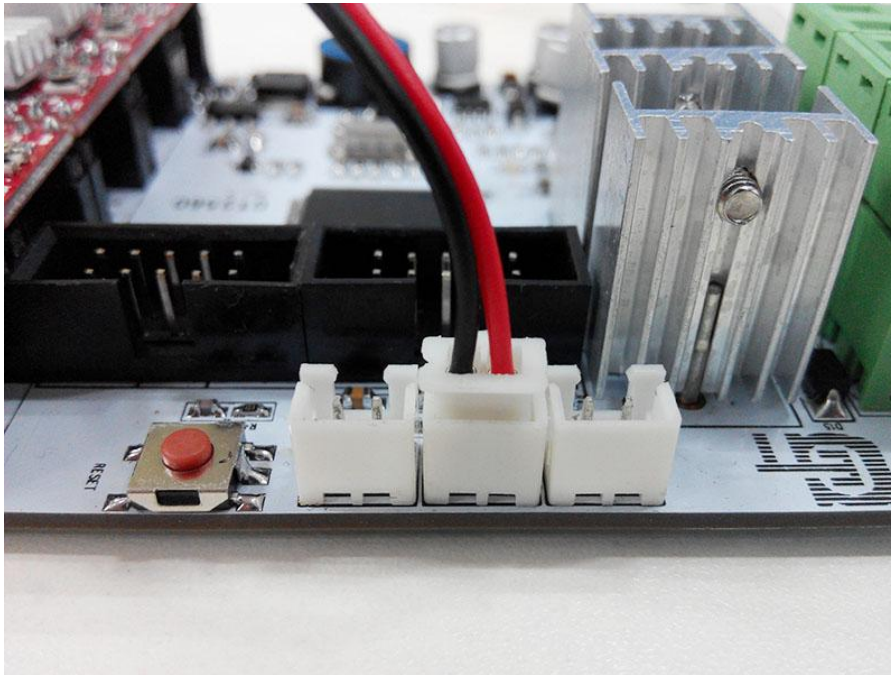

5 Connect wires for endstop.

Step 1. Connect the X-axis endstop to the X-max connector plug.

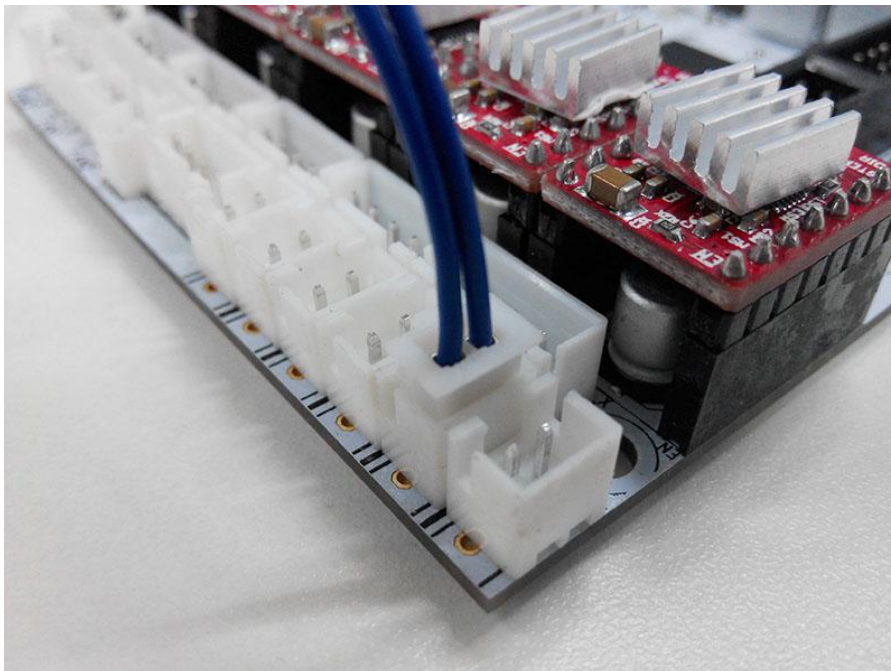

Step 2. Connect Y-axis endstop to the Y-max connector plug.

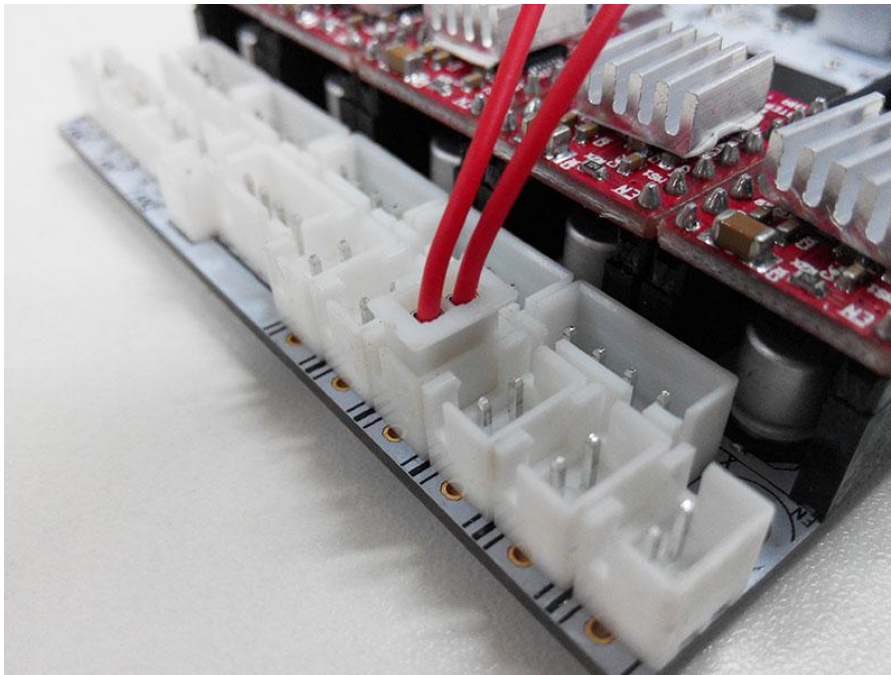

Step 3. Connect Z-axis endstop to the Z-max connector plug.

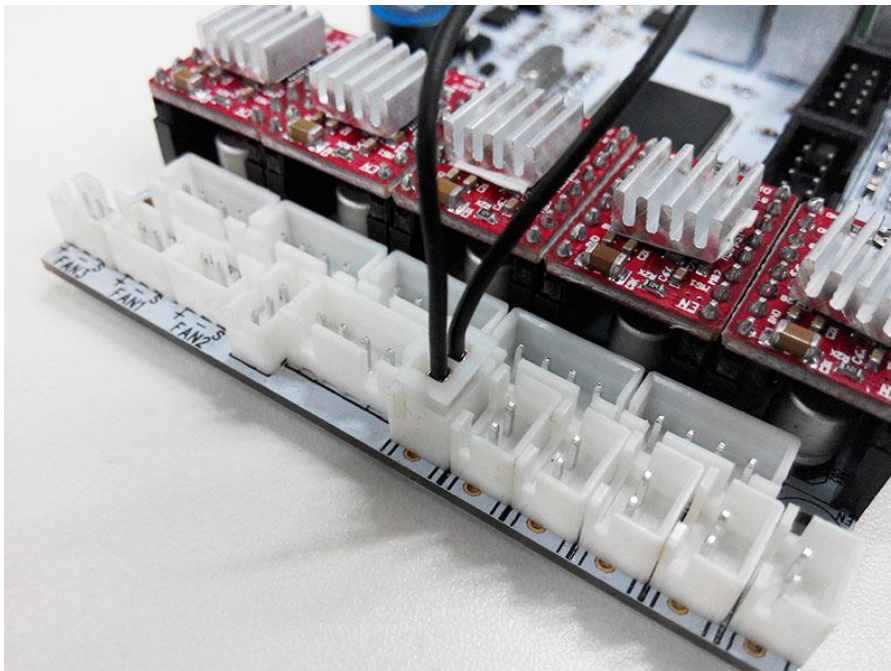

Step 4. Connect the auto-leveling probe endstop to the Z-min connector plug.

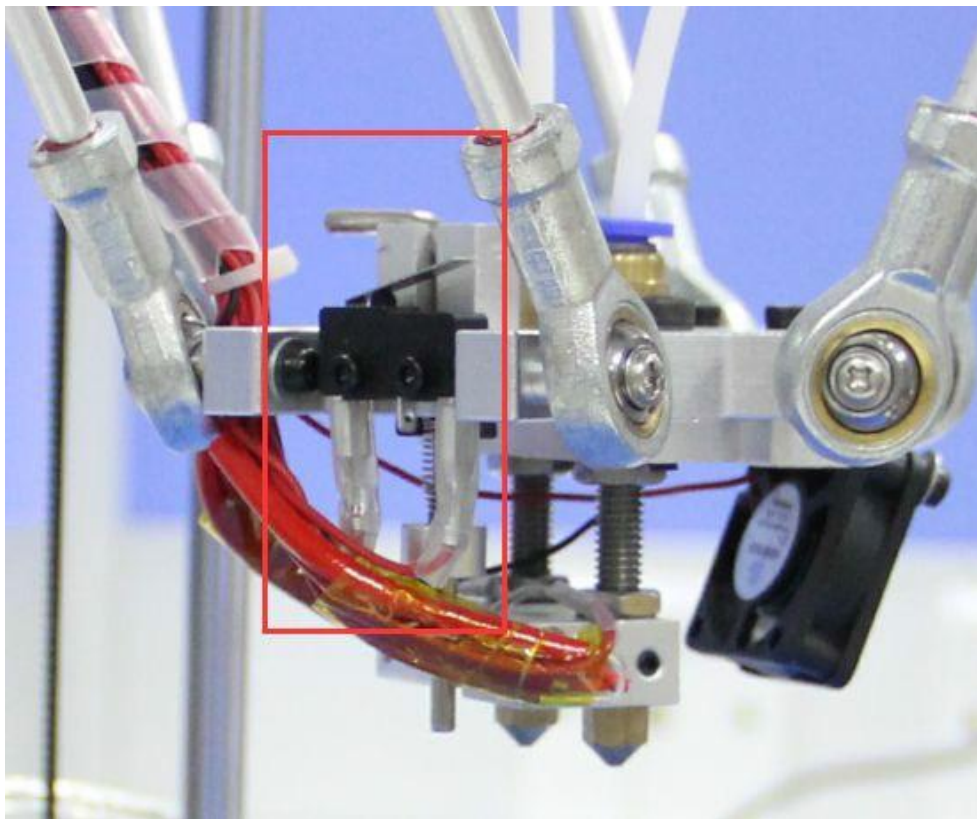
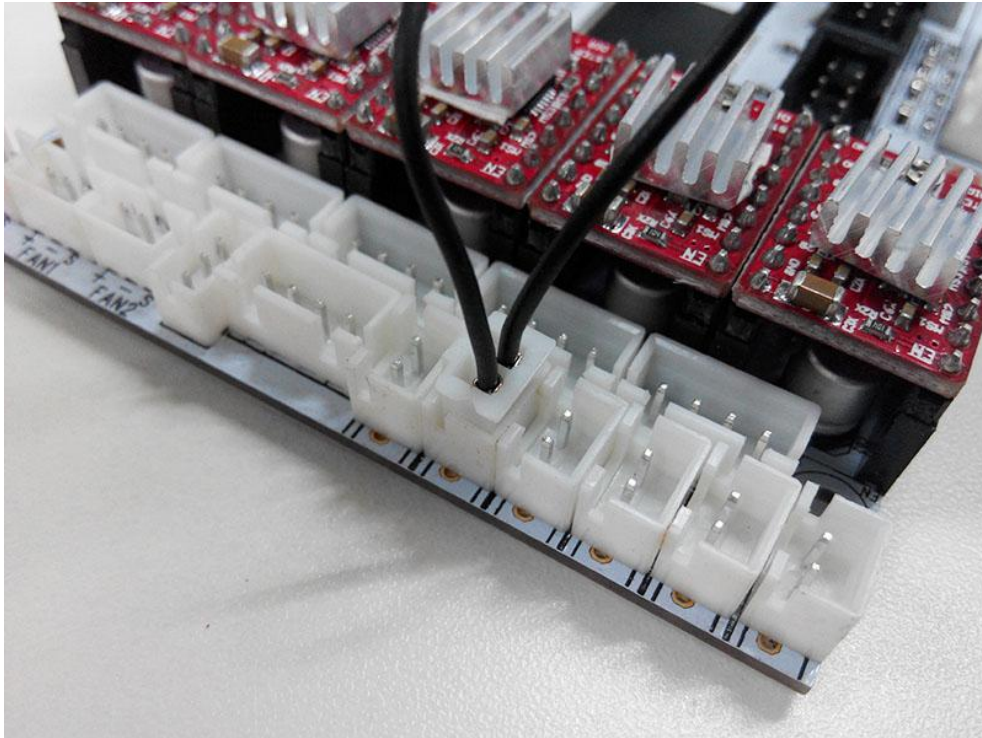

6Connect wires for Fan.

Step 1. Connect control board fan to the FAN1 connector plug.

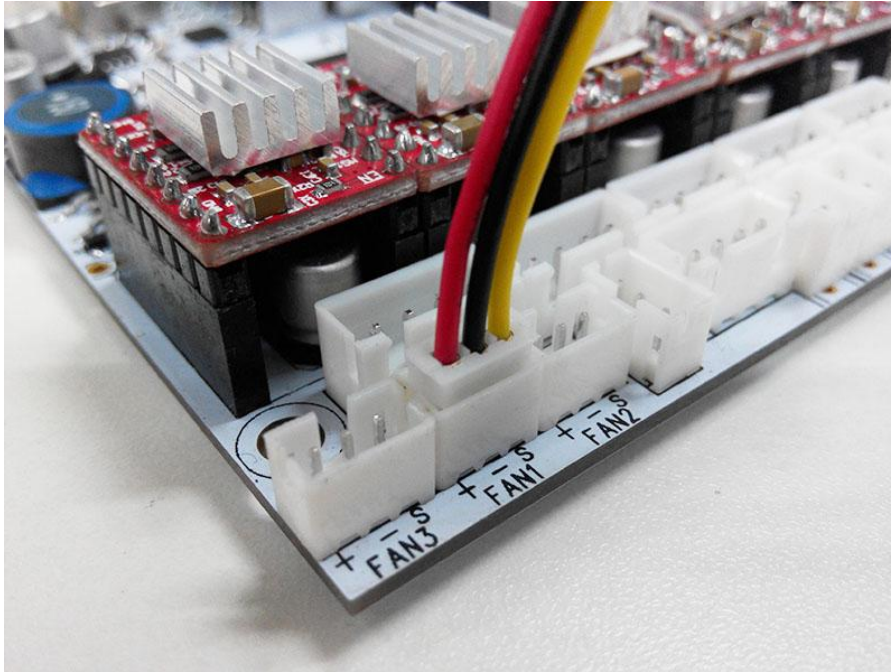

Step 2. Connect either extruder fans to FAN2 connector plug and the other extruder fan to FAN3 connector plug.

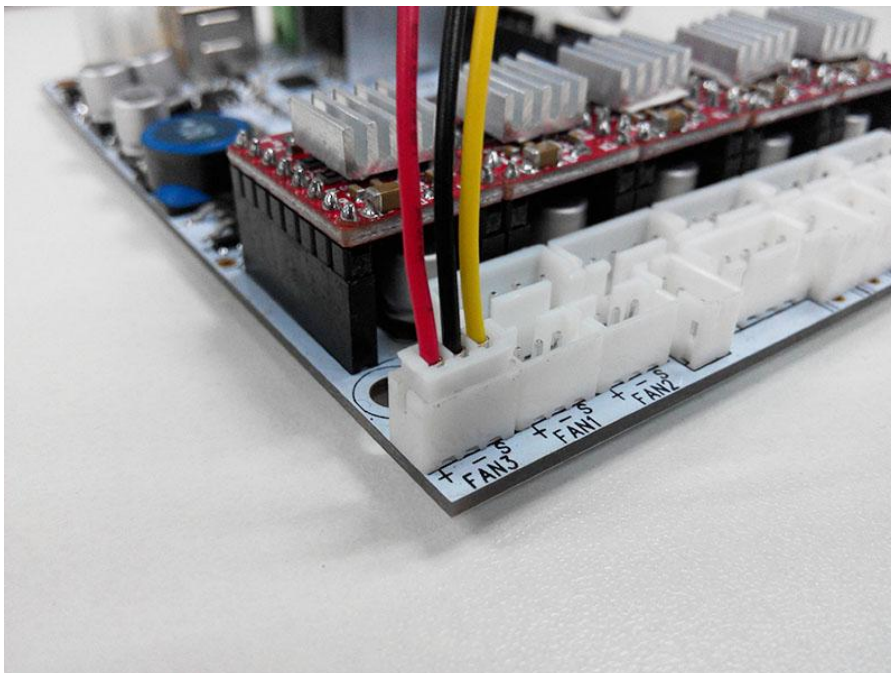

Step 3. Connect the hot-end fan to the FAN-PWM connector plug.

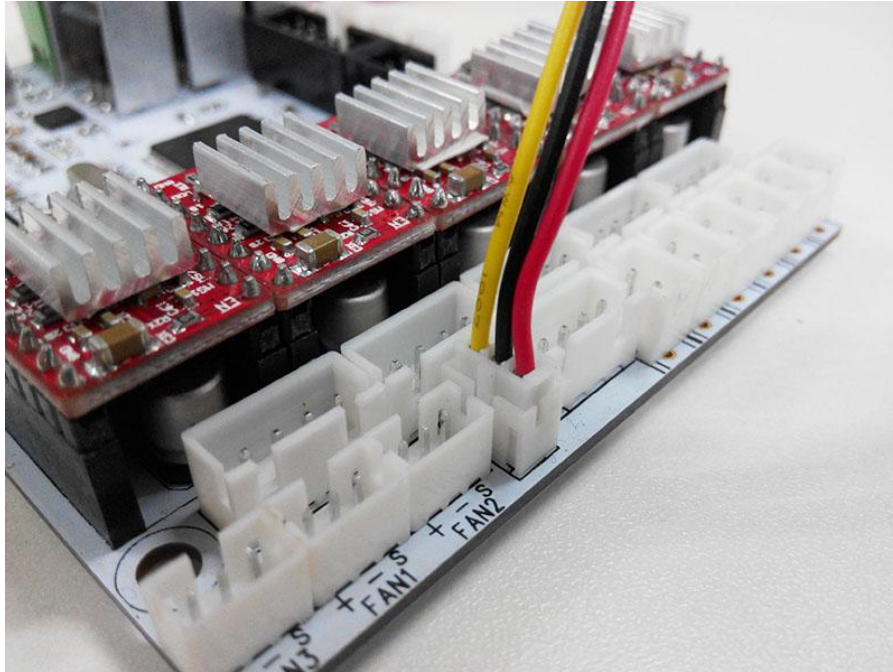

7 Connect wires for LCD panel.

Note: The LCD controller comes with connectors and two cables, they are not to be mixed up as this could cause damage to the LCD, SD card reader or controller board, so please take care.

Step 1. Connect the first cable from EXP1 to LCD, then connect the second cable from EXP2 to SD card.

EXP1 to LCD

EXP2 to SD card

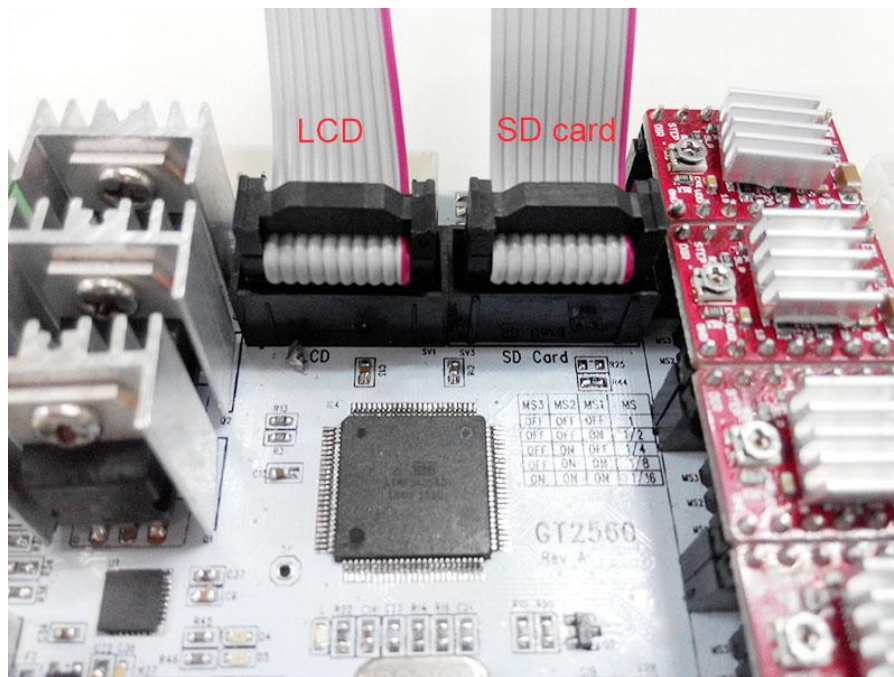
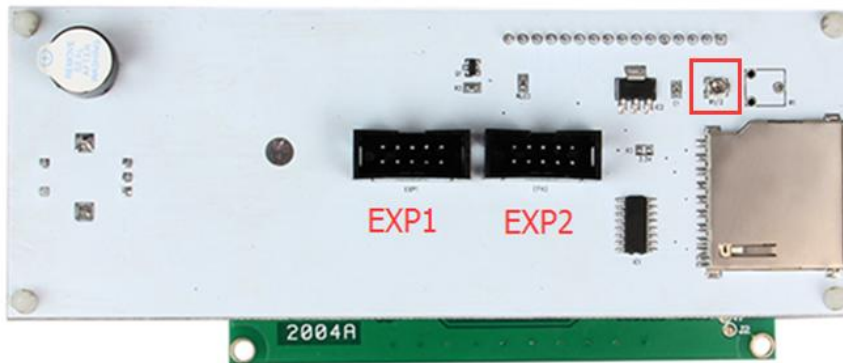

Note: There is a small screw above the SD card reader. If the LCD text display is not very clear, you can make some adjustments with this screw to improve the displayed text. Do not over turn or apply aggressive force as you may damage the potentiometer.

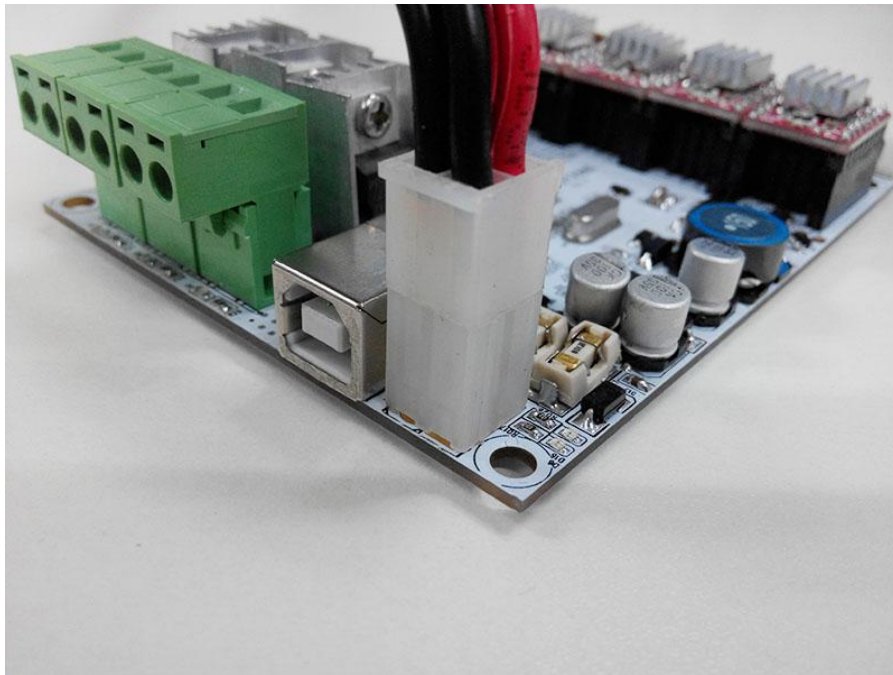

8 Connect wires for power input.



9 Connect the power cable to the input connector of PSU

Name	Part NO.	Qty	Pic
3D Power cable	NO.59	1	
Power Supply Unit	NO.58	1	
Power Cable	NO.60	1	

Caution: You must take extreme care at this point. Ensure that you connect the correct wires to the corresponding locations on the power supply.

Step 1. Connect the wires as shown below.



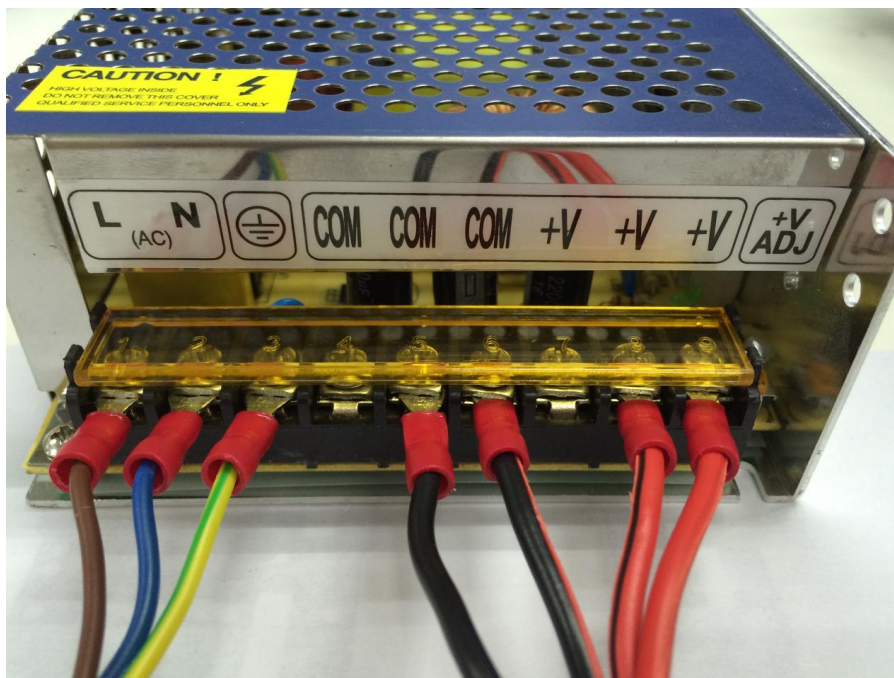

This wiring is for G2s Pro.

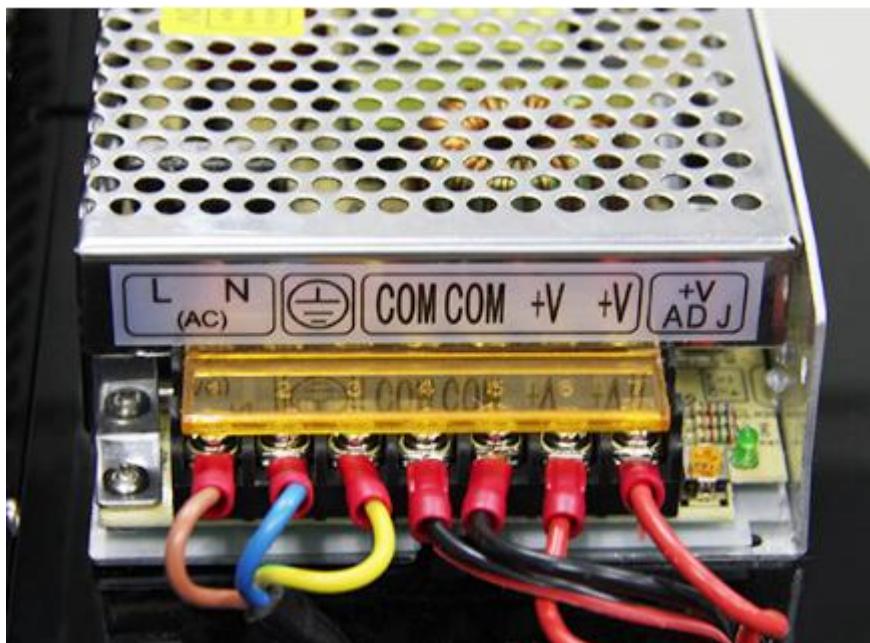

This wiring is for G2 pro has only 7 screws.



For both power supply units, you should take note of the colors and their corresponding connection as a mistake can cause you harm or damage the printer. If you are unsure of your skills and abilities here, please consult a professional.

BROWN		Live (L)
BLUE		Neutral (N)
GREEN / YELLOW		Ground (GND)
RED		Positive (+)
BLACK		Common (COM)

That completes the wiring of GT2560 controller.

As the power supply unit (PSU) is not physically connected to the actual printer, it is best to be kept next to the printer, you should take good care of it; keep it away from kids and pets.

[Videos](#)

13 Tidy out the wires

Use the provided spiral coil and zip ties to neatly bundle the those wires together.

If you bundle the wires up before wiring the printer, you are advised to mark each wire with its function or location so as not to mix them up.

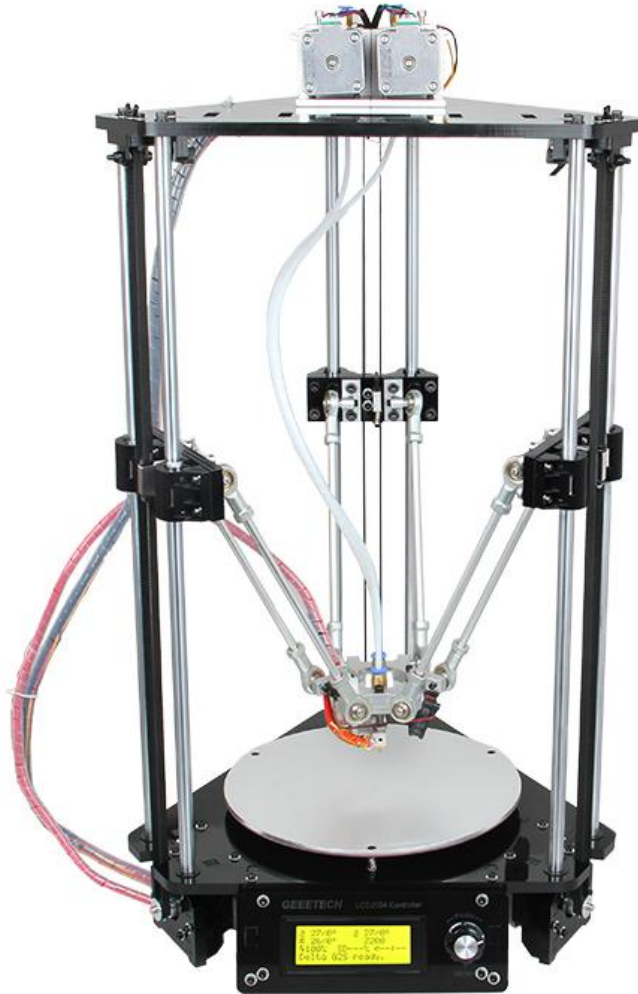

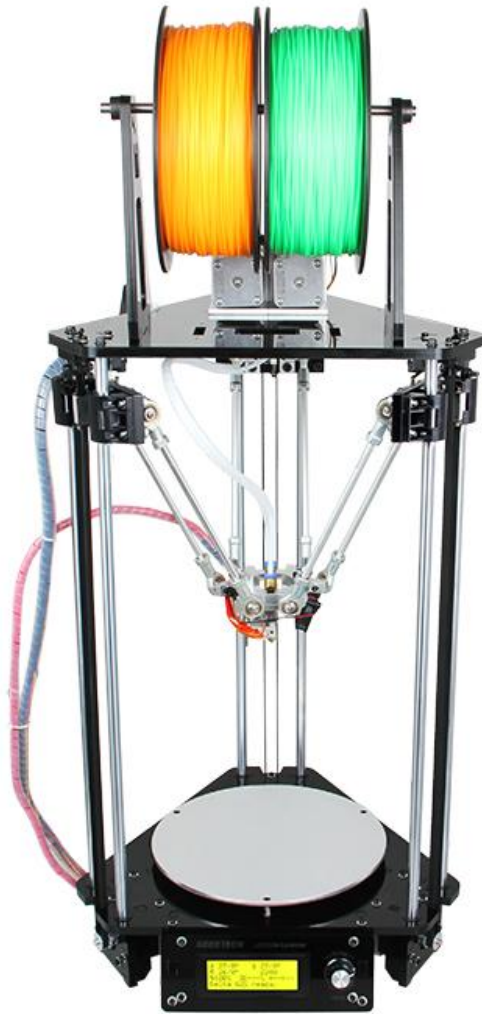

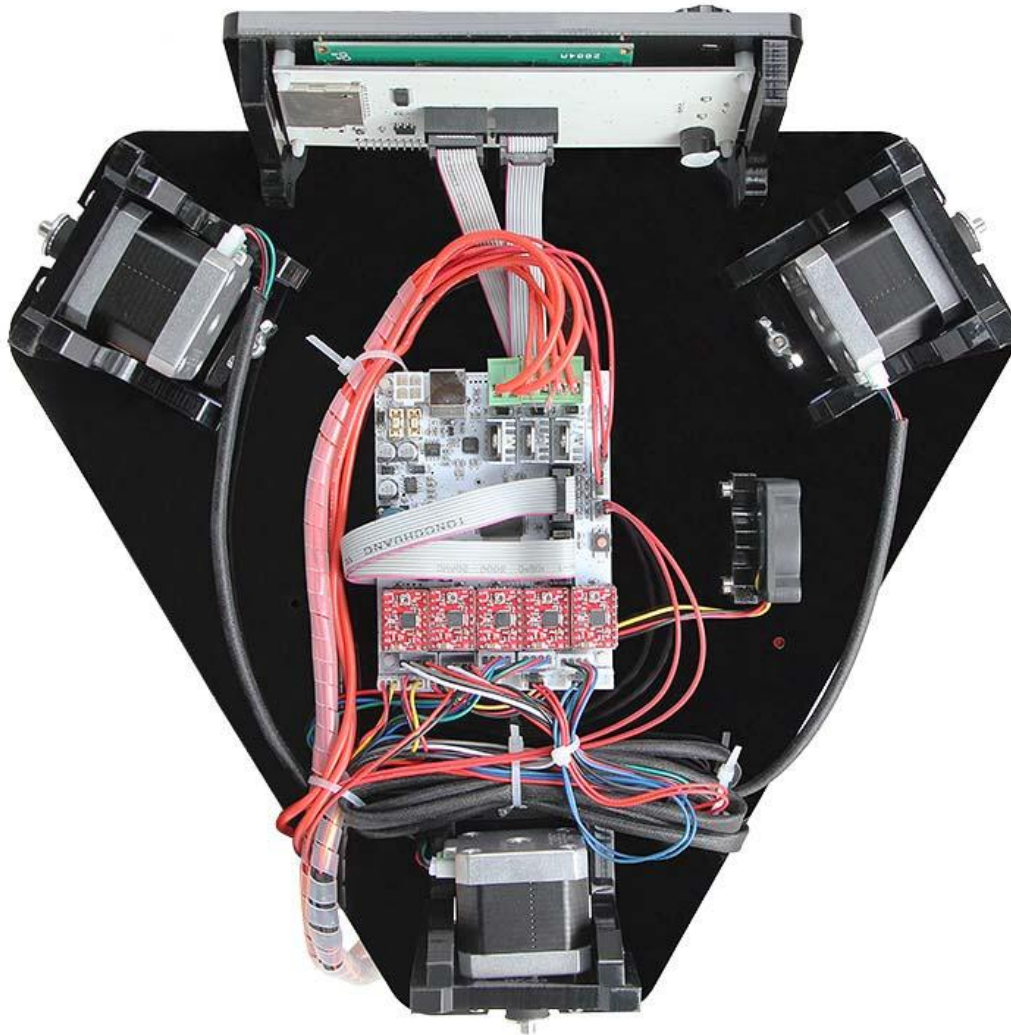

The Rostock mini G2 (G2s) has been fully assembled.

14 Tips

Before printing your first project, it is critical that you correctly calibrate the printer. Skipping or rushing this step will result in frustration and failed prints later, so it is important to take the time to make sure your printer is correctly set up.

Each printer will have its own calibration procedure and this manual can not attempt to cover every variations and possible scenario. Instead we have provided you with a list of key points that should be addressed as your configuration and set up procedure.

- Frame is stable and correctly aligned.
- Rods are correctly aligned
- Belts are taut.
- Driving wheel turns smoothly
- Bed is level in relation to the path of the extruder.
- Filament rolls freely from the spool, without causing too much tension on the extruder.
- Current for stepper motors is set to the correct level.
- Wires are correctly connected
- Couplings and pulleys are fixed tightly

Firmware settings are correct including: axis movement speeds and acceleration; temperature control; end-stops; motor directions.

Extruder is calibrated in the firmware with the correct steps per mm of filament.

The point regarding the extruder step rate is vital. Slic3r expects that the machine will accurately produce a set amount of filament when told to do so. Too much will result in blobs and other imperfections in the print, too little will result in gaps and poor inter-layer adhesion.